

OUR POPULAR RANGE

CATALOGUE ISSUE 3.3

www.internationalcastorcoltd.co.uk

PRODUCT SELECTION GUIDE

LIGHT

FURNITURE GENERAL PURPOSE

Loads from 40kg - 100kg

SERIES TW/TWB/TWCC  9	SERIES AGSR  10	SERIES AGBPVC  10	SERIES AGBPVC  10	SERIES AGBPU  11	SERIES AGRPU  12	SERIES AGBEPVC  13	SERIES GYPP  14
SERIES GYPXB  15	SERIES GYPN  16	SERIES GYBSB  17	SERIES GYBNBJ  18	SERIES DPTPR  19	SERIES DRLTPR  20	SERIES DRLGRG  21	SERIES DRLGRG  22
SERIES GDGRG  23	SERIES LWATPR  24	SERIES LWATPRBJ  25	SERIES LWATPRBJBOX  25	SERIES DR2TPR  26	SERIES DR2NY  27	SERIES DRLPP  28	

LIGHT / MEDIUM

INDUSTRIAL



Loads from 60kg - 350kg

SERIES LWNY / GDNY  29	SERIES DRNYHD  29	SERIES DRPP  30	SERIES DRNY  31	SERIES DRPS  32	SERIES DRBS  33	SERIES DRGR  34	SERIES DRTPR  35
SERIES DRBN  36	SERIES DREA  37	SERIES DRRT  38	SERIES DRCI  39	SERIES LVHT  40	SERIES LVHT/G  40	SERIES LVHTBIG  40	SERIES DRPNO  41
SERIES DRPNR  42	SERIES DREP  43	SERIES DRPN  44	SERIES DRPX  45	SERIES DROPU  46	SERIES DRPT  47	SERIES DRPTA  48	

MEDIUM

WASTE CONTAINER

Loads from 175kg - 205kg

SERIES DRWCPS  49	SERIES DRWCBS  49
---	---

MEDIUM STAINLESS STEEL INDUSTRIAL

Loads from 60kg - 350kg



MEDIUM / HEAVY INDUSTRIAL

Loads from 150kg - 800kg

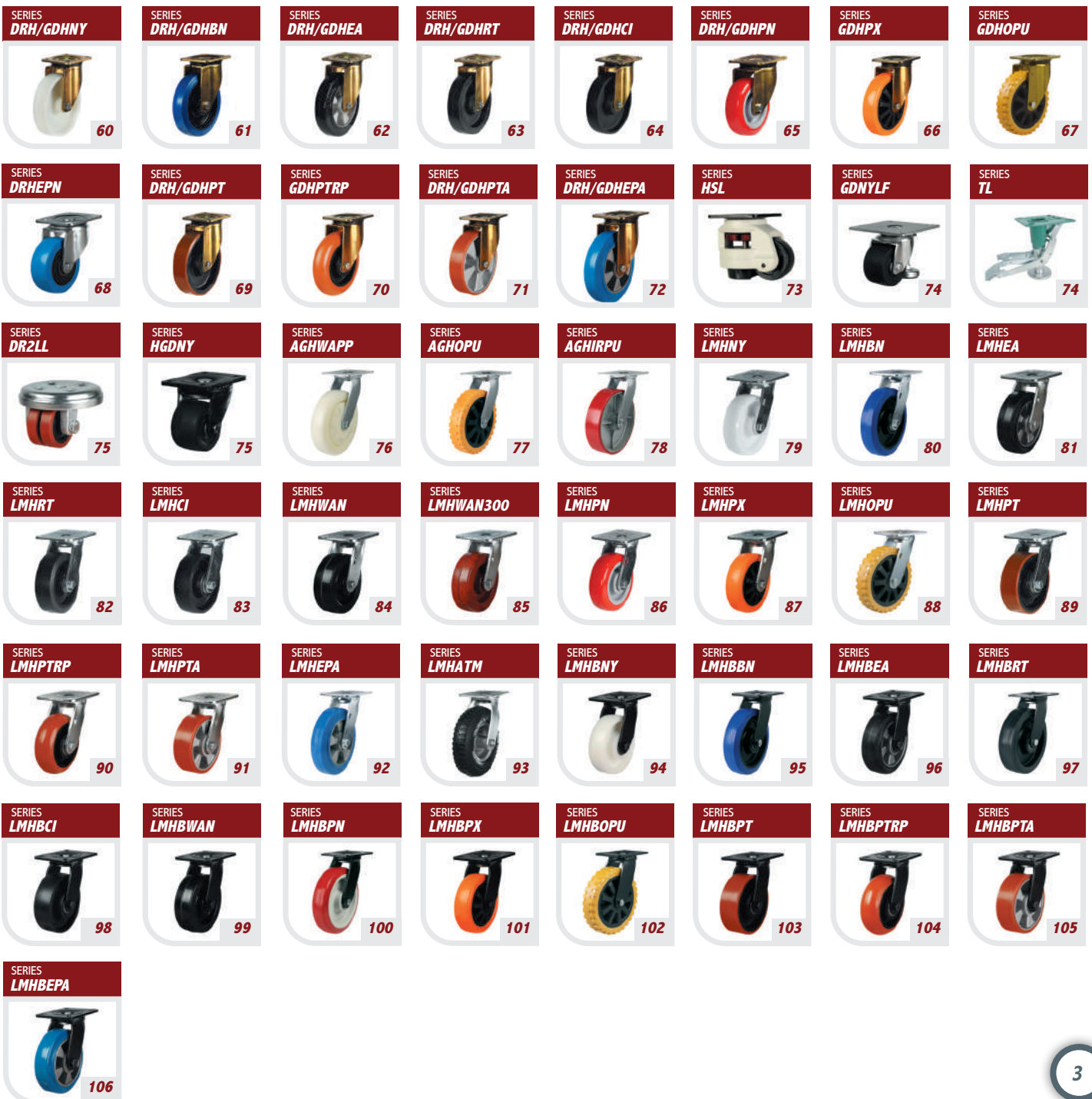

PRODUCT SELECTION GUIDE

HEAVY / EXTRA HEAVY **INDUSTRIAL**

Loads from 275kg - 1500kg

SERIES NGRNY  107	SERIES NGRRT  108	SERIES NGREA  109	SERIES NGRCI  110	SERIES NGRPN  111	SERIES NGRPX  112	SERIES NGROPUBJ  113	SERIES NGRPT  114
SERIES NGRPTRP  115	SERIES NGRPTA  116	SERIES NGREPA  117	SERIES DNGRNY  118	SERIES DNGRRT  119	SERIES DNGRCI  120	SERIES DNGRPN  121	SERIES DNGRPX  122
SERIES DNGRPT  123	SERIES DNGRPTRP  124	SERIES DNGRPTA  125	SERIES DNGREPA  126				

EXTRA HEAVY **INDUSTRIAL**

Loads from 1600kg - 2500kg

SERIES NXHCNY  127	SERIES NXHDI  128	SERIES NXHPT  129	SERIES DNXHNY  130	SERIES DNXHCI  131	SERIES DNXHPT  132
---	--	--	---	---	---

ULTRA EXTRA HEAVY **INDUSTRIAL**

Loads from 2500kg - 10000kg

SERIES DWHPT  133	SERIES DWDHPT  134	SERIES DWUHPT  135
--	---	---

EXPANDERS / ACCESSORIES / MISCELLANEOUS ITEMS / STEPS & TROLLEYS



WHEELS DESIGNED WITH WATER IN MIND



One Centrally located Sealed Ball Bearing protected by two plastic Guards which OFFER A HIGH LEVEL OF PROTECTION AGAINST water AND DIRT INGRESS. (PAGE 144)



CATALOGUE SYMBOL KEY













Diameter (mm)	Tread Width (mm)	Double Tread (mm)	Bearing Type (mm)	Plate Size (mm)	Hole Centres (mm)	Bolt Hole (mm)	Stem (mm)	Threaded Stem (mm)	Hole Size (mm)	Offset (mm)
Overall Height (mm)	Load Capacity (KG)	Hub Length (mm)	Bore (mm)	Diameter (mm)	Overall Width (mm)	Swivel Offset (mm)	Tread Width (mm)	Stem Hole Diameter (mm)	Overall Height (mm)	Plain Bearing
Roller Bearing	Ball Bearing	Double Ball Bearing	Mounting Height (mm)	Extended Height (mm)	Boundary of Bore or Keyway	High Temperature Wheel (°C)	Wash Friendly Wheel Cap	Stainless Steel	Anti Static Wheel	Round Profile
Elastic Polyurethane										

GLOSSARY

Bolt Hole Fitting Single Hole Fixing
Plate Fitting Square Or Rectangular Flat Plate
Swivel Able To Rotate 360 Degrees
Fixed Rigid Position Only Able To Move Forward Or Backward
SWB Able To Rotate 360 Degrees & Brake Wheel & Swivel Head
BK Able To Rotate 360 Degrees & Brake Wheel Only

Load Capacity Unit Of Measurement Under Ideal Working Conditions
Elastic Resilient Material
Non-marking Unlikely To Mark
Pressed Steel Formed Shape From Flat Sheet
Fabricated Fabricated from Welded Components
Self Colour Untreated Material Colour
Nylon Generic word often used for Nylon or Polypropylene

PRODUCT SELECTION GUIDE

WHEEL	BASIC DATA			TECHNICAL DATA						FLOOR COMPATIBILITY					ENVIRO		PAGE
	CODE	DIAMETER	LOAD	HARDNESS	BEARING	TEMP -	TEMP +	ROLLING RESISTANCE	TRACTIVE EFFORT	COMPACT	RESIN	LOOSE	ROUGH	MARKS	OPERATING NOISE	FLOOR SURFACE WEAR	
	WPSB	80-200	65-205	82+/-5 A	≡≡≡	20	60	4	7	✓	✓	✓	✓	✓	9	9	136
	WBSB WLBSB	80-400	65-700	82+/-5 A	≡≡≡	20	60	4	7	✓	✓	✓	✓	✓	9	9	137 142
	WGRB	80-200	65-205	80+/-5 A	≡≡≡	20	60	4	7	✓	✓	✓	✓	✗	9	9	137
	WGR	50-125	40-100	80 shore A	≡≡	20	60	4	7	✓	✓	✓	✓	✗	9	9	136
	WTPR	50-150	40-100	85 shore A	≡≡≡	20	60	8	9	✓	✓	✗	✗	✗	8	9	136
	WTPRBJG	100-200	70-100	85 shore A	≡≡●●	20	70	8	9	✓	✓	✗	✗	✗	8	9	136
	WTPRBJBOX	100-200	70-200	80+/-5 shore A	≡≡●●	20	50	8	9	✓	✓	✗	✗	✗	8	9	136
	WPNO WPNOB WPNOBJ	80-200	100-500	60+/-5 shore D	≡≡≡	20	60	9	9	✓	✓	✗	✗	✗	7	8	138
	WPNOBJG	80-125	180-220	60+/-5 shore D	≡≡●●	20	60	9	9	✓	✓	✗	✗	✗	7	8	142
	WPNR	100-125	200-260	60+/-5 shore D	≡≡≡	20	60	9	9	✓	✓	✗	✗	✗	7	8	138
	WEPN	80-200	100-250	80+/-5 shore A	≡≡	25	80	10	8	✓	✓	✗	✗	✗	9	10	139
	WEPNBJ	100-125	250-280	82+/-5 shore A	≡≡●●	25	80	10	8	✓	✓	✗	✗	✗	9	10	139
	WPNBJ	100-200	250-500	92+/-3 shore A	≡≡●●	30	70	9	9	✓	✓	✗	✗	✗	7	8	138
	WPXBJ	100-200	380-600	92+/-3 shore A	≡≡●●	20	70	9	9	✓	✓	✗	✗	✗	7	8	138
	WPP WNY	50-250	50-1400	60+/-5 shore D 70+/-5 shore D	≡≡	20 25	60 80	9 10	8 9	✓	✓	✗	✗	✗	4 3	2 2	142 143
	WPPB WNYB	50-200	40-800	60+/-5 shore D 70+/-5 shore D	≡≡≡	20 25	60 80	9 10	8 9	✓	✓	✗	✗	✗	4 3	2 2	142 143
	WNYBJ	100-200	800-1400	70+/-3 shore D	≡≡●●	25	80	10	10	✓	✓	✗	✗	✗	3	2	143
	WNYBJG	80-125	180-250	70+/-3 shore D	≡≡●●	25	80	10	10	✓	✓	✗	✗	✗	3	2	142

PRODUCT SELECTION GUIDE

WHEEL	BASIC DATA			TECHNICAL DATA						FLOOR COMPATIBILITY					ENVIRO		PAGE
	CODE	DIAMETER	LOAD	HARDNESS	BEARING	TEMP -	TEMP +	ROLLING RESISTANCE	TRACTIVE EFFORT	COMPACT	RESIN	LOOSE	ROUGH	MARIS	OPERATING NOISE	FLOOR SURFACE WEAR	
	WBNB WBNBJ	80-200	150-400	75 shore A		20	70	8	8	✓	✓	✓	✓	✗	9	10	137
	WPTBJ	50-4000	80-3500	92+/-3 shore A		30	80	8	8	✓	✓	✗	✗	✗	8	8	140
	WPTPB	125-300	450-1500	92+/-3 shore A		30	110	8	8	✓	✓	✗	✗	✗	8	8	139
	WPTBJRP	100-200	300-8000	92+/-3 shore A		30	80	9	9	✓	✓	✗	✗	✗	9	8	140
	WPTABJ	80-200	200-800	99		20	70	8	8	✓	✓	✗	✗	✗	8	8	139
	WEPABJ-80	100-200	300-800	80+/-3 shore A		20	80	9	9	✓	✓	✓	✓	✗	8	10	139
	WEABJ	80-250	100-500	75+/-5 shore A		20	50	8	8	✓	✓	✓	✓	✗	8	10	137
	WRTBJ	100-300	180-650	75+/-5 shore A		20	50	8	8	✓	✓	✓	✓	✗	8	10	137
	WCI WCIB WCIBJ	50-250	135-1500	180-200 HB		80	120	10	10	✓	✓	✗	✗	✗	1	1	141
	WHT	100	150	90+/-5 shore D		18	220	8	6	✓	✓	✗	✗	✗	3	2	141
	WHTG	100	200	90+/-5 shore D		30	260	8	6	✓	✓	✗	✗	✗	3	2	141
	WHTBJG	80-125	150-225	85+/-5 shore D		40	260	8	8	✓	✓	✗	✗	✗	4	3	142
	WAN WAN220	100-200	200-500	90+/-5 shore D		20	120 220	7	7	✓	✓	✗	✗	✗	4	4	141
	WAN300	100-200	200-500	90+/-5 shore D		20	300	7	7	✓	✓	✗	✗	✗	4	4	141
	WPSNW	200	205	82+/-5 A		0	60	3	7	✓	✓	✓	✓	✓	9	9	49

NUMBER KEY

1	2	3	4	5	6	7	8	9	10
POOR			GOOD				IDEAL		



PRODUCT SELECTION GUIDE

WHEEL	BASIC DATA			TECHNICAL DATA						FLOOR COMPATIBILITY					ENVIRO		PAGE
	CODE	DIAMETER	LOAD	HARDNESS	BEARING	TEMP -	TEMP +	ROLLING RESISTANCE	TRACTIVE EFFORT	COMPACT	RESIN	LOOSE	ROUGH	MARKS	OPERATING NOISE	FLOOR SURFACE WEAR	
	WBNBJ	100-200	150-400	70+/-5 shore A		-20	70	8	8	✓	✓	✓	✓	✗	9	10	137
	WSHM	200	125	82+/-5 A		-20	60	4	6	✓	✓	✓	✓	✓	9	9	144
	WATMBJ	300	105	X		-20	60	3	3	✓	✓	✓	✓	✓	9	10	144
	WATMBJ OFFSET	260	85	X		-20	60	3	3	✓	✓	✓	✓	✓	9	10	144/145
	WATP	200-260	75-125	X		-20	60	3	3	✓	✓	✓	✓	✓	9	10	144/145
	WATMRBM	370-400	180-300	X		-20	60	3	3	✓	✓	✓	✓	✓	9	10	145
	WATPL	400	120	X		-20	40	3	4	✓	✓	✓	✓	✗	9	10	145
	WATML	400	120	X		-20	40	3	4	✓	✓	✓	✓	✗	9	10	145
	WATMLRB	400	120	X		-20	40	3	4	✓	✓	✓	✓	✗	9	10	145
	WAPP	100-200	260-450	70+/-3 shore D		-20	60	9	8	✓	✓	✗	✗	✗	4	2	142
	WCNYBJ	100-200	4500-7000	80 shore D		-25	80	10	9	✓	✓	✗	✗	✗	4	2	143
	WOPUBJ	100-200	200-400	92+/-3 shore A		20	70	9	9	✓	✓	✗	✗	✗	7	8	138
	WIRPUBJ	100-200	260-450	92+/-3 shore A		30	80	9	9	✓	✓	✗	✗	✗	8	8	140
	WHPT	200-400	1800-4500	92+/-3 shore A		30	80	9	9	✓	✓	✗	✗	✗	8	8	140
	WDIBJ	100-300	2500-2900	180-200HB		80	120	10	10	✓	✓	✗	✗	✗	1	1	140
	WRTBJHT	100	300	75+/-5 shore A		40	250	8	8	✓	✓	✓	✓	✗	8	10	141

NUMBER KEY

1	2	3	4	5	6	7	8	9	10
POOR			GOOD				IDEAL		





FURNITURE

SERIES: TW/TWB/TWCC

BRACKET: **PLASTIC**
WHEEL: **TWIN BLACK NYLON**
BEARING: **PLAIN**



TW/TWB							
TW-40	40	10/10	40	8	40	46	40
TW-50	50	11/11	47	8	50	54	50
TW-60	60	13/13	52	9	55	65	60
TWB-40	40	10/10	40	8	40	46	40
TWB-50	50	11/11	47	8	50	54	50
TWB-60	60	13/13	52	9	55	65	60



TW/TWB							
TW-75	75	14	68	10	62	84	100
TWB-75	75	14	68	10	62	84	100
TW-100	100	16	72	11	92	102	100
TWB-100	100	16	72	11	92	102	100

FITTINGS

	PLATE CODE	CASTOR SIZES	PLATE	HOLE CENTRE	HOLE DIAMETER
T1		40 & 50	38x38	25.4x25.4	5.2
T2		75	55x65	41x51	6.5
T3		100	55x65	41x51	8

	FRICTION STEM CODE	CASTOR SIZES (mm)	FRICTION
FS1	+ Required length	40/50	11x22

	THREAD STEM CODE	CASTOR SIZES (mm)	THREAD X LENGTH
TS1	+ Thread x length	40/50	8x15 / 10x15 / 10x25
TS2	+ Thread x length	60	8x15 / 10x20
TS3	+ Thread x length	75	12x25
TS4	+ Thread x length	100	12x25

	WOOD SOCKET / STEM CODE	CASTOR SIZES (mm)	WOOD SOCKET / STEM
WS1		40 & 50	9x29 / 8x38



HARD TREAD

TWCC CHAIR CASTOR				STEM			
CTW-50	50	11/11	54	11x22	50	57	50



SOFT PU TREAD

				STEM			
PUCTW-50	50	11/11	45	11x22	50	59	50

LIGHT

GENERAL PURPOSE

SERIES: **AGSR/AGBPVC/AGPP**

BRACKET: **PRESSED STEEL**
 WHEEL: **SOLID RUBBER**
 ON **PLASTIC CENTRE**
 BEARING: **PLAIN**



LIGHT



AGSR										
SWIVEL									KG	
50AG4SR		50	20		60x48	46x35	6.3	28.5	64	30



AGSR										
FIXED									KG	
50AG8SR		50	20		60x41	45x25	6.3		64	30



AGSR										
BRAKED									KG	
50AG4SRBK		50	20		60x48	46x35	6.3	28.5	64	30



AGBPVC										
SWIVEL									KG	
50AG4BPVC		50	20		66x50	53x23	6.3	23	62	30



AGBPVC										
FIXED									KG	
50AG8BPVC		50	20		66x40	53x23	6.3		62	30



AGBPVC										
BRAKED									KG	
50AG4BPVCBK		50	20		66x50	53x23	6.3	23	62	30



AGPP										
SWIVEL									KG	
50AG4PP		50	20		66x50	53x23	6.3	23	62	30



AGBPVC										
FIXED									KG	
50AG8PP		50	20		66x40	53x23	6.3		62	30



AGBPVC										
BRAKED									KG	
50AG4PPBK		50	20		66x50	53x23	6.3	23	62	30



GENERAL PURPOSE

SERIES: AGBPU

BRACKET: **PRESSED STEEL**
 WHEEL: **POLYURETHANE ON NYLON**
 BEARING: **BALL BEARING**

	AGBPU SWIVEL									
	50AG4BPUBJ	50	25		70x51	53x35	8	23	73	50
	AGBPU FIXED									
	50AG8BPUBJ	50	25		70x55	53x35	8		73	50
	AGBPU SWIVEL BRAKED									
	50AG4BPUBJSWB	50	25		70x51	53x35	8	23	73	50
	AGBPU BOLTHOLE									
	50GYBH10BPNBJ	50	24				6	23	71	50
	AGBPU BOLTHOLE BRAKED									
	50GYBH10BPNBJSWB	50	24				6	23	71	50
	AGBPU THREADED STEM SWIVEL									
	50GYTSMBPNBJ	50	24				M10 X 30	23	71	50
	AGBPU THREADED STEM SWIVEL BRAKED									
	50GYTSMBPNBJSWB	50	24				M10 X 30	23	71	50

LIGHT

GENERAL PURPOSE

SERIES: AGRPU

BRACKET: **PRESSED STEEL**
 WHEEL: **POLYURETHANE ON NYLON**
 BEARING: **BALL BEARING**



LIGHT



AGRP SWIVEL									
50AG4RPUBJ	50	25		70x51	53x35	8	23	74	50



AGRP FIXED									
50AG8RPUBJ	50	25		70x55	53x35	8		74	50



AGRP SWIVEL BRAKED									
50AG4RPUBJSWB	50	25		70x51	53x35	8	23	74	50



AGRP BOLTHOLE									
50GYBH10RPNBJ	50	24				11	23	71	40

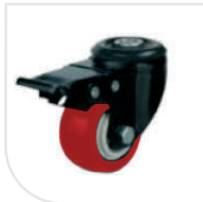

AGRP BOLTHOLE BRAKED									
50GYBH10RPNBJSWB	50	24				11	23	71	50



AGRP THREADED STEM SWIVEL									
50GYTSMRPNBJ	50	24				M10 X 30	23	71	50



AGRP THREADED STEM SWIVEL BRAKED									
50GYTSMRPNBJSWB	50	24				M10 X 30	23	71	50



GENERAL PURPOSE

SERIES: AGBE PVC

BRACKET: **PRESSED STEEL**
 WHEEL: **POLYURETHANE ON NYLON**
 BEARING: **BALL BEARING**



AGBE PVC

SWIVEL

50AG4BE PVCBJ



50



17



17



50



AGBE PVC

FIXED

50AG8BE PVCBJ



50



17



17



50



AGBE PVC

SWIVEL BRAKED

50AG4BE PVCBJSWB



50



17



17



50

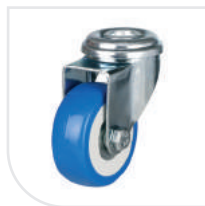

AGBE PVC

BOLT HOLE

50AGBH10BE PVCBJ



50



17



17



50



AGBE PVC

BOLT HOLE BRAKED

50AGBH10BE PVCBJSWB



50



17



17



50

LIGHT

GENERAL PURPOSE

SERIES: GYPP

BRACKET: **PRESSED STEEL**
 WHEEL: **WHITE POLYPROPYLENE**
 BEARING: **DOUBLE BALL BEARING**



LIGHT



GYPP SWIVEL									
75GY4PPBJ	75	32		93x62	72x45	8.5		105	80
100GY4PPBJ	100	32		93x62	72x45	8.5		130	90
125GY4PPBJ	125	32		93x62	72x45	8.5		155	100



GYPP FIXED									
75GY8PPBJ	75	32		93x62	72x45	8.5		105	80
100Y8PPBJ	100	32		93x62	72x45	8.5		130	90
125GY4PPBJ	125	32		93x62	72x45	8.5		155	100



GYPP SWIVEL BRAKED									
75GY4PPBJSWB	75	32		93x62	72x45	8.5		105	80
100GY4PPBJSWB	100	32		93x62	72x45	8.5		130	90
125GY4PPBJSWB	125	32		93x62	72x45	8.5		155	100



GENERAL PURPOSE

SERIES: GYPXB

BRACKET: **PRESSED STEEL**
 WHEEL: **POLY NYLON**
 BEARING: **DOUBLE BALL BEARING**



GYPXB									
SWIVEL									
75GY4PXB	75	32		93x62	72x45	8.5		105	80
100GY4PXB	100	32		93x62	72x45	8.5		130	90
125GY4PXB	125	32		93x62	72x45	8.5		155	100



GYPXB									
FIXED									
75GY8PXB	75	32		93x62	72x45	8.5		105	80
100GY8PXB	100	32		93x62	72x45	8.5		130	90
125GY8PXB	125	32		93x62	72x45	8.5		155	100



GYPXB									
SWIVEL BRAKED									
75GY4PXBJSWB	75	32		93x62	72x45	8.5		105	80
100GY4PXBJSWB	100	32		93x62	72x45	8.5		130	90
125GY4PXBJSWB	125	32		93x62	72x45	8.5		155	100

LIGHT

GENERAL PURPOSE

SERIES: GYPN

BRACKET: **PRESSED STEEL**

WHEEL: **POLY NYLON**

BEARING: **DOUBLE BALL BEARING**



LIGHT



GYPBX SWIVEL										
75GY4PNBJ	75	32		93x62	72x45	8.5			105	80
100GY4PNBJ	100	32		93x62	72x45	8.5			130	90
125GY4PNBJ	125	32		93x62	72x45	8.5			155	100



GYPBX FIXED									
75GY8PNBJ	75	32		93x62	72x45	8.5		105	80
100GY8PNBJ	100	32		93x62	72x45	8.5		130	90
125GY8PNBJ	125	32		93x62	72x45	8.5		155	100



GYPBX SWIVEL BRAKED									
75GY4PNBJSWB	75	32		93x62	72x45	8.5		105	80
100GY4PNBJSWB	100	32		93x62	72x45	8.5		130	90
125GY4PNBJSWB	125	32		93x62	72x45	8.5		155	100

GENERAL PURPOSE

SERIES: GYBSB

BRACKET: **PLASTIC**
 WHEEL: **RUBBER AND STEEL CORE**
 BEARING: **ROLLER BEARING**



GYBSB SWIVEL									
100GY4BSB	100	27		100x80	80x60	9		128	60



GYBSB FIXED									
100GY8BSB	100	27		100x80	80x60	9		128	60



GYBSB SWIVEL BRAKED									
100GY4BSB SWB	100	27		100x80	80x60	9		128	60



GYBSB BOLT HOLE									
100GYBH12BSB	100	27					12	128	60



GYBSB BOLT HOLE BRAKED									
100GYBH12BSB SWB	100	27					12	128	60

LIGHT

GENERAL PURPOSE

SERIES: GYBNBJ

BRACKET: **PRESSED STEEL**
 WHEEL: **ELASTIC RUBBER**
 BEARING: **ROLLER**



LIGHT



GYBNBJ
SWIVEL

100AG4BNBJ



100



33



100x80



80x60



9



128



100



100



GYBNBJ
FIXED

100AG8BNBJ



100



33



100x80



80x60



9



128



100



100



GYBNBJ
SWIVEL BRAKED

100AG4BNBJSWB



100



33



100x80



80x60



9



128



100



100



GYBNBJ
BOLT HOLE

100AGBH12BNBJ



100



33



13



128



100



100



GYBNBJ
BOLT HOLE BRAKED

100AGBH12BNBJSWB



100



33



13



128



100



100

APPARATUS

SERIES: DTPTR

BRACKET: **PLASTIC**
WHEEL: **SYNTHETIC NON-MARKING**
BEARING: **BALL BEARING**



DTPTR SWIVEL



75DP4TPR	75	32		93x64	75x45	8.5	40	124	75
100DP4TPR	100	32		93x64	75x45	8.5	34	148	85
125DP4TPR	125	32		93x64	75x45	8.5	34	174	100
150DP4TPR	150	32		93x64	75x45	8.5	34	198	110



DTPTR SWIVEL BRAKED



75DP4TPRSWB	75	32		93x64	75x45	8.5	40	124	75
100DP4TPRSWB	100	32		93x64	75x45	8.5	34	148	85
125DP4TPRSWB	125	32		93x64	75x45	8.5	34	174	100
150DP4TPRSWB	150	32		93x64	75x45	8.5	34	198	110



DTPTR SWIVEL DIRECTIONAL LOCK



75DP4TPRDL	75	32		93x64	75x45	8.5	40	124	75
100DP4TPRDL	100	32		93x64	75x45	8.5	34	148	85
125DP4TPRDL	125	32		93x64	75x45	8.5	34	174	100
150DP4TPRDL	150	32		93x64	75x45	8.5	34	198	110



DTPTR SWIVEL THREADED STEM



75DPTSM12TPR	75	32					M12x20	40	118	75
100DPTSM12TPR	100	32					M12x20	34	142	85
125DPTSM12TPR	125	32					M12x20	34	168	100
150DPTSM12TPR	150	32					M12x20	34	192	110



DTPTR BRAKED THREADED STEM



75DPTSM12TPRSWB	75	32					M12x20	40	118	75
100DPTSM12TPRSWB	100	32					M12x20	34	142	85
125DPTSM12TPRSWB	125	32					M12x20	34	168	100
150DPTSM12TPRSWB	150	32					M12x20	34	192	110



DTPTR DIRECTIONAL THREADED STEM



75DPTSM12TPRDL	75	32					M12x20	40	118	75
100DPTSM12TPRDL	100	32					M12x20	34	142	85
125DPTSM12TPRDL	125	32					M12x20	34	168	100
150DPTSM12TPRDL	150	32					M12x20	34	192	110

LIGHT





















































APPARATUS

SERIES: DRLTPR

BRACKET: **PRESSED STEEL**
 WHEEL: **SYNTHETIC NON-MARKING**
GREY RUBBER ON PLASTIC CENTRE
 BEARING: **PLAIN**



LIGHT

	DRLTPR SWIVEL									
	50DRL4TPR	50	20		50x50	35x35	6.3	25	73	40
	75DRL4TPR	75	23		60x60	43x43	6.3	32	100	50
	100DRL4TPR	100	27		75x75	57x57	8.3	38	130	75
	125DRL4TPR	125	27		75x75	57x57	8.3	40	153	90
	DRLTPR BRAKED									
	50DRL4TPRSWB	50	20		50x50	35x35	6.3	25	73	40
	75DRL4TPRSWB	75	23		60x60	43x43	6.3	32	100	50
	100DRL4TPRSWB	100	27		75x75	57x57	8.3	38	130	75
	125DRL4TPRSWB	125	27		75x75	57x57	8.3	40	153	90
	DRLTPR BOLT HOLE									
	50DRLBH10TPR	50	20				10.5	25	71	40
	75DRLBH10TPR	75	23				10.5	32	95	50
	100DRLBH12TPR	100	27				12.2	38	128	75
	125DRLBH12TPR	125	27				12.2	38	150	90
	DRLTPR BOLT HOLE BRAKED									
	50DRLBH10TPRSWB	50	20				10.5	25	71	40
	75DRLBH10TPRSWB	75	23				10.5	32	95	50
	100DRLBH12TPRSWB	100	27				12.2	38	128	75
	125DRLBH12TPRSWB	125	27				12.2	38	150	90

APPARATUS

SERIES: DRLTPRAZ

BRACKET: **PRESSED STEEL**
 WHEEL: **SYNTHETIC NON-MARKING**
ANTISTATIC GREY RUBBER
ON PLASTIC CENTRE
 BEARING: **PLAIN**



DRLTPRAZ SWIVEL											
50DRL4TPRAZ	50	20			50x50	35x35	6.3	25	73	40	
75DRL4TPRAZ	75	23			60x60	43x43	6.3	32	100	50	
100DRL4TPRAZ	100	27			75x75	57x57	8.3	38	130	75	
125DRL4TPRAZ	125	27			75x75	57x57	8.3	40	153	90	



DRLTPRAZ BRAKED											
50DRL4TPRSWBAZ	50	20			50x50	35x35	6.3	25	73	40	
75DRL4TPRSWBAZ	75	23			60x60	43x43	6.3	32	100	50	
100DRL4TPRSWBAZ	100	27			75x75	57x57	8.3	38	130	75	
125DRL4TPRSWBAZ	125	27			75x75	57x57	8.3	40	153	90	



DRLTPRAZ BOLT HOLE											
50DRLBH10TPRAZ	50	20						10.5	25	71	40
75DRLBH10TPRAZ	75	23						10.5	32	95	50
100DRLBH12TPRAZ	100	27						12.2	38	128	75
125DRLBH12TPRAZ	125	27						12.2	38	150	90



DRLTPRAZ BOLT HOLE BRAKED											
50DRLBH10TPRSWBAZ	50	20						10.5	25	71	40
75DRLBH10TPRSWBAZ	75	23						10.5	32	95	50
100DRLBH12TPRSWBAZ	100	27						12.2	38	128	75
125DRLBH12TPRSWBAZ	125	27						12.2	38	150	90

LIGHT

APPARATUS

SERIES: DRLGRG

BRACKET: **PRESSED STEEL**
 WHEEL: **GREY NON-MARKING**
 RUBBER ON PLASTIC CENTRE
 BEARING: **PLAIN**



LIGHT



DRLGRG

SWIVEL

50DRL4GRG	50	17		50x50	35x35	6.3	25	73	40	40
75DRL4GRG	75	21		60x60	43x43	6.3	32	100	50	50
100DRL4GRG	100	27		75x75	57x57	8.3	38	130	80	80
125DRL4GRG	125	27		75x75	57x57	8.3	40	153	100	100



DRLGRG

BRAKED

50DRL4GRGSWB	50	17		50x50	35x35	6.3	25	73	40	40
75DRL4GRGSWB	75	21		60x60	43x43	6.3	32	100	50	50
100DRL4GRGSWB	100	27		75x75	57x57	8.3	38	130	80	80
125DRL4GRGSWB	125	27		75x75	57x57	8.3	40	153	100	100



DRLGRG

BOLT HOLE

50DRLBH10GRG	50	17				10.5	25	71	40	40
75DRLBH10GRG	75	21				10.5	32	95	50	50
100DRLBH12GRG	100	27				12.2	38	128	80	80
125DRLBH12GRG	125	27				12.2	40	150	100	100



DRLGRG

BOLT HOLE BRAKED

50DRLBH10GRGSWB	50	17				10.5	25	71	40	40
75DRLBH10GRGSWB	75	21				10.5	32	95	50	50
100DRLBH12GRGSWB	100	27				12.2	38	128	80	80
125DRLBH12GRGSWB	125	27				12.2	40	150	100	100

EXPANDERS



APPARATUS

SERIES: GDGRG

BRACKET: **PRESSED STEEL**
 WHEEL: **SYNTHETIC NON-MARKING**
 GREY RUBBER ON PLASTIC CENTRE
 BEARING: **PLAIN**



GDGRG SWIVEL										
50GD4GRG	50	17		50x50	35x35	6.5	28	72	40	
75GD4GRG	75	24		65x65	45x45	8.5	35	103	50	
100GD4GRG	100	24		65x65	45x45	8.5	39	124	80	



GDGRG FIXED									
50GD8GRG	50	17		50x50	35x35	6.5		72	40
75GD8GRG	75	24		65x65	45x45	8.5		103	50
100GD8GRG	100	24		65x65	45x45	8.5		124	80



GDGRG BRAKED									
50GD4GRGSWB	50	17		50x50	35x35	6.5	28	72	40
75GD4GRGSWB	75	24		65x65	45x45	8.5	35	103	50
100GD4GRGSWB	100	24		65x65	45x45	8.5	39	124	80



GDGRG BOLT HOLE									
50GDBH10GRG	50	17				10.5	28	70	40
75GDBH10GRG	75	24				10.5	39	100	50
100GDBH10GRG	100	24				10.5	35	121	80



GDGRG BOLT HOLE BRAKED									
50GDBH10GRGSWB	50	17				10.5	28	70	40
75GDBH10GRGSWB	75	24				10.5	39	100	50
100GDBH10GRGSWB	100	24				10.5	35	121	80

EXPANDERS



LIGHT

APPARATUS

SERIES: LWATPR

BRACKET: **PRESSED STEEL**
 WHEEL: **SYNTHETIC NON-MARKING**
GREY RUBBER ON PLASTIC CENTRE
 BEARING: **PLAIN**



LIGHT



LWATPR SWIVEL										
100LWA4TPR	100	32		67x77	51.5x61.5	8.5	38	135	90	90
125LWA4TPR	125	32		67x77	51.5x61.5	8.5	41	160	110	110
150LWA4TPR	150	32		67x77	51.5x61.5	8.5	45	184.5	130	130



LWATPR BRAKED										
100LWA4TPRSWB	100	32		67x77	51.5x61.5	8.5	38	135	90	90
125LWA4TPRSWB	125	32		67x77	51.5x61.5	8.5	41	160	110	110
150LWA4TPRSWB	150	32		67x77	51.5x61.5	8.5	45	184.5	130	130



LWATPR BOLT HOLE									
100LWABH12TPR	100	32				12.5	38	135	90
125LWABH12TPR	125	32				12.5	41	160	110
150LWABH12TPR	150	32				12.5	45	184.5	130



LWATPR BOLT HOLE BRAKED									
100LWABH12TPRSWB	100	32				12.5	38	135	90
125LWABH12TPRSWB	125	32				12.5	41	160	110
150LWABH12TPRSWB	150	32				12.5	45	184.5	130

EXPANDERS

AVAILABLE

PAGE
148



APPARATUS

SERIES: LWATPRBJ / BOX

BRACKET: PRESSED STEEL
 WHEEL: SYNTHETIC NON-MARKING
 GREY RUBBER ON PLASTIC CENTRE
 BEARING: BALL BEARING



LWATPRBJ SWIVEL										
100LWA4TPRBIG	100	32		67x77	51.5x61.5	8.5	38	135	90	
125LWA4TPRBIG	125	32		67x77	51.5x61.5	8.5	41	160	110	
150LWA4TPRBIG	150	32		67x77	51.5x61.5	8.5	45	184.5	130	
* 100LWA4TPRBIGBOX	100	32		67x77	51.5x61.5	8.5	38	135	70	
125LWA4TPRBIGBOX	125	32		67x77	51.5x61.5	8.5	41	160	90	



LWATPRBJ BRAKED										
100LWA4TPRBIGSWB	100	32		67x77	51.5x61.5	8.5	38	135	90	
125LWA4TPRBIGSWB	125	32		67x77	51.5x61.5	8.5	41	160	110	
150LWA4TPRBIGSWB	150	32		67x77	51.5x61.5	8.5	45	184.5	130	
* 100LWA4TPRBIGSWBBOX	100	32		67x77	51.5x61.5	8.5	38	135	70	
125LWA4TPRBIGSWBBOX	125	32		67x77	51.5x61.5	8.5	41	160	90	



LWATPRBJ BOLT HOLE									
100LWABH12TPRBIG	100	32				12.5	38	135	90
125LWABH12TPRBIG	125	32				12.5	41	160	110
150LWABH12TPRBIG	150	32				12.5	45	184.5	130
* 100LWABH12TPRBIGBOX	100	32				12.5	38	135	70
125LWABH12TPRBIGBOX	125	32				12.5	41	160	90



LWATPRBJ BOLT HOLE BRAKED									
100LWABH12TPRBIGSWB	100	32				12.5	38	135	90
125LWABH12TPRBIGSWB	125	32				12.5	41	160	110
150LWABH12TPRBIGSWB	150	32				12.5	45	184.5	130
* 100LWABH12TPRBIGSWBBOX	100	32				12.5	38	135	70
125LWABH12TPRBIGSWBBOX	125	32				12.5	41	160	90

BOX CASTORS

SWIVEL	BRAKED	BOLT HOLE	BOLT HOLE BRAKED	BOX WHEEL
*	*	*	*	

PAGE 106

EXPANDERS

AVAILABLE

PAGE 148

LIGHT

APPARATUS

SERIES: DR2TPR

BRACKET: **PRESSED STEEL**
 WHEEL: **SYNTHETIC NON-MARKING**
GREY RUBBER ON PLASTIC CENTRE
 BEARING: **PLAIN**



LIGHT



DR2TPR
TWIN
SWIVEL

50DR24TPR



50



20/20



60x60



46x46



6.2



26



72



60



DR2TPR
TWIN
BRAKED

50DR24TPRSWB



50



20/20



60x60



46x46



6.2



26



72



60



DR2TPR
TWIN
BOLT HOLE

50DR2BH10TPR



50



20/20



10.5



26



71



60



DR2TPR
TWIN BOLT
HOLE BRAKED

50DR2BH10TPRSWB



50



20/20



10.5



26



71



60

EXPANDERS



AVAILABLE

PAGE

148

APPARATUS

SERIES: DR2NY

BRACKET: **PRESSED STEEL**
 WHEEL: **NYLON**
 BEARING: **PLAIN**



DR2NY TWIN SWIVEL										
50DR24NY	50	17/17		60x60	46x46	6.2	26	72	60	60



DR2NY TWIN BRAKED										
50DR24NYSWB	50	17/17		60x60	46x46	6.2	26	72	60	60



DR2NY TWIN BOLT HOLE											
50DR2BH1ONY	50	17/17				10.5	26	72	60	60	



DR2NY TWIN BOLT HOLE BRAKED											
50DR2BH1ONYSWB	50	17/17				10.5	26	72	60	60	

LIGHT

EXPANDERS



APPARATUS

SERIES: DRLPP

BRACKET: **PRESSED STEEL**
 WHEEL: **POLYPROPYLENE**
 BEARING: **PLAIN**



LIGHT



DRLPP SWIVEL										
50DRL4PP	50	20			50x50	35x35	6.3	25	73	40
75DRL4PP	75	21			60x60	43x43	6.3	32	100	50
100DRL4PP	100	27			75x75	57x57	8.3	38	130	80
125DRL4PP	125	27			75x75	57x57	8.3	40	153	100



DRLPP BRAKED										
50DRL4PPSWB	50	20			50x50	35x35	6.3	25	73	40
75DRL4PPSWB	75	21			60x60	43x43	6.3	32	100	50
100DRL4PPSWB	100	27			75x75	57x57	8.3	38	130	80
125DRL4PPSWB	125	27			75x75	57x57	8.3	40	153	100



DRLPP BOLT HOLE										
50DRLBH10PP	50	20					10.5	25	71	40
75DRLBH10PP	75	21					10.5	32	95	50
100DRLBH12PP	100	27					12.2	38	128	80
125DRLBH12PP	125	27					12.2	40	150	100



DRLPP BOLT HOLE BRAKED										
50DRLBH10PPSWB	50	20					10.5	25	71	40
75DRLBH10PPSWB	75	21					10.5	32	95	50
100DRLBH12PPSWB	100	27					12.2	38	128	80
125DRLBH12PPSWB	125	27					12.2	40	150	100

BLACK WHEEL AVAILABLE



EXPANDERS





INDUSTRIAL

SERIES: LWNY/GDNY DRNYHD

BRACKET: **PRESSED STEEL**
WHEEL: **NYLON**
BEARING: **PLAIN**

LIGHT / MEDIUM



LWNY										
SWIVEL										
50LW4NY	50	25		66x47.5	54x24	6.3	26	65	60	
63LW4NY	63	28		98x70	76x40	8.5	28	81	80	
75LW4NY	75	30		104x80	86x60	8.5	26	96	110	
100LW4NY	100	32		130x102	103x76	10	38	127	140	
75GD4NY	75	26		104x80	86x60	8.5	25	95	140	



LWNY										
FIXED										
50LW8NY	50	25		66x45	54x24	6.3		65	60	
63LW8NY	63	28		98x55	82x25	8.5		81	80	
75LW8NY	75	30		102x64	83x35	8.5		96	110	
100LW8NY	100	32		130x69	110x38	10		127	140	
75GD8NY	75	26		102x64	83x35	8.5		95	140	



GDNY										
BRAKED										
75GD4NYBK	75	26		104x80	86x60	8.5	25	95	140	

WIDE TREAD

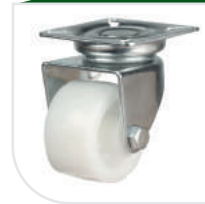

DRNYHD										
WIDE TREAD SWIVEL										
50DR4NYHD	50	30		60x60	43x43	6.2	26	72	80	

WIDE TREAD



DRNYHD										
WIDE TREAD BRAKED										
50DR4NYHDSWB	50	30		60x60	43x43	6.2	26	72	80	

INDUSTRIAL

SERIES: DRPP

BRACKET: **PRESSED STEEL**
 WHEEL: **POLYPROPYLENE**
 BEARING: **ROLLER**



LIGHT / MEDIUM



DRPP SWIVEL

80DR4PPB	80	35		105x85	80x60	9	37.5	106	150
100DR4PPB	100	35		105x85	80x60	9	40	128	180
125DR4PPB	125	35		105x85	80x60	9	47	152	220



DRPP FIXED

80DR8PPB	80	35		105x85	80x60	9		106	150
100DR8PPB	100	35		105x85	80x60	9		128	180
125DR8PPB	125	35		105x85	80x60	9		152	220



DRPP BRAKED

80DR4PPBSWB	80	35		105x85	80x60	9	37.5	106	150
100DR4PPBSWB	100	35		105x85	80x60	9	40	128	180
125DR4PPBSWB	125	35		105x85	80x60	9	47	152	220



DRPP BOLT HOLE

80DRBH12PPB	80	35					12.1	37.5	106
100DRBH12PPB	100	35					12.1	40	128
125DRBH12PPB	125	35					12.1	47	152



DRPP BOLT HOLE BRAKED

80DRBH12PPBSWB	80	35					12.1	37.5	106
100DRBH12PPBSWB	100	35					12.1	40	128
125DRBH12PPBSWB	125	35					12.1	47	152

EXPANDERS



INDUSTRIAL

SERIES: DRNY

BRACKET: **PRESSED STEEL**
 WHEEL: **NYLON**
 BEARING: **PLAIN**



LIGHT / MEDIUM



DRNY										
SWIVEL										
80DR4NY	80	35			105x85	80x60	9	37.5	106	200
100DR4NY	100	35			105x85	80x60	9	40	128	200
125DR4NY	125	35			105x85	80x60	9	47	152	270
★ 125DR4NYLP	125	35			135x110	105x80	11	53	157	270
150DR4NY	150	40			135x105	105x80	11	65	185	350
160DR4NY	160	45			135x105	105x80	11	65	195	350
200DR4NY	200	50			135x105	105x80	11	68	237	350



DRNY										
FIXED										
80DR8NY	80	35			105x85	80x60	9		106	200
100DR8NY	100	35			105x85	80x60	9		128	200
125DR8NY	125	35			105x85	80x60	9		152	270
★ 125DR8NYLP	125	35			135x110	105x80	11		157	270
150DR8NY	150	40			135x105	105x80	11		185	350
160DR8NY	160	45			135x105	105x80	11		195	350
200DR8NY	200	50			135x105	105x80	11		237	350



DRNY										
BRAKED										
80DR4NYSWB	80	35			105x85	80x60	9	37.5	106	200
100DR4NYSWB	100	35			105x85	80x60	9	40	128	200
125DR4NYSWB	125	35			105x85	80x60	9	47	152	270
★ 125DR4NYSWBLP	125	35			135x110	105x80	11	53	157	270
150DR4NYSWB	150	40			135x105	105x80	11	65	185	350
160DR4NYSWB	160	45			135x105	105x80	11	65	195	350
200DR4NYSWB	200	50			135x105	105x80	11	68	237	350



DRNY										
BOLT HOLE										
80DRBH12NY	80	35					12.1	37.5	106	200
100DRBH12NY	100	35					12.1	40	128	200
125DRBH12NY	125	35					12.1	47	152	270
150DRBH12NY	150	40					12.1	65	185	350
160DRBH12NY	160	45					12.1	65	195	350
200DRBH12NY	200	50					12.1	68	237	350



DRNY										
BOLT HOLE BRAKED										
80DRBH12NYSWB	80	35					12.1	37.5	106	200
100DRBH12NYSWB	100	35					12.1	40	128	200
125DRBH12NYSWB	125	35					12.1	47	152	270
150DRBH12NYSWB	150	40					12.1	65	185	350
160DRBH12NYSWB	160	45					12.1	65	195	350
200DRBH12NYSWB	200	50					12.1	68	237	350

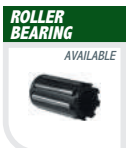

★ LARGE PLATE OPTION AVAILABLE

INDUSTRIAL

SERIES: DRPS

BRACKET: **PRESSED STEEL**
 WHEEL: **RUBBER**
ON PLASTIC CENTRE
 BEARING: **ROLLER**



LIGHT / MEDIUM



DRPS										
SWIVEL										KG
80DR4PSB	80	30		105x85	80x60	9	37.5	106	65	
100DR4PSB	100	32		105x85	80x60	9	40	128	80	
125DR4PSB	125	37		105x85	80x60	9	47	152	100	
★ 125DR4PSBLP	125	37		135x110	105x80	11	53	157	100	
160DR4PSB	160	40		135x105	105x80	11	65	195	175	
200DR4PSB	200	50		135x105	105x80	11	68	237	205	



DRPS									
FIXED									KG
80DR8PSB	80	30		105x85	80x60	9		106	65
100DR8PSB	100	32		105x85	80x60	9		128	80
125DR8PSB	125	37		105x85	80x60	9		152	100
★ 125DR8PSBLP	125	37		135x110	105x80	11		157	100
160DR8PSB	160	40		135x105	105x80	11		195	175
200DR8PSB	200	50		135x105	105x80	11		237	205



DRPS									
BRAKED									KG
80DR4PSBSWB	80	30		105x85	80x60	9	37.5	106	65
100DR4PSBSWB	100	32		105x85	80x60	9	40	128	80
125DR4PSBSWB	125	37		105x85	80x60	9	47	152	100
★ 125DR4PSBSWBLP	125	37		135x110	105x80	11	53	157	100
160DR4PSBSWB	160	40		135x105	105x80	11	65	195	175
200DR4PSBSWB	200	50		135x105	105x80	11	68	237	205



DRPS										
BOLT HOLE									KG	
80DRBH12PSB	80	30					12.1	37.5	106	65
100DRBH12PSB	100	32					12.1	40	128	80
125DRBH12PSB	125	37					12.1	47	152	100
160DRBH12PSB	160	40					12.1	65	195	175
200DRBH12PSB	200	50					12.1	68	237	205



DRPS										
BOLT HOLE BRAKED									KG	
80DRBH12PSBSWB	80	30					12.1	37.5	106	65
100DRBH12PSBSWB	100	32					12.1	40	128	80
125DRBH12PSBSWB	125	37					12.1	47	152	100
160DRBH12PSBSWB	160	40					12.1	65	195	175
200DRBH12PSBSWB	200	50					12.1	68	237	205

BLACK WHEEL AVAILABLE



★ LARGE PLATE OPTION AVAILABLE

INDUSTRIAL

SERIES: DRBS

BRACKET: **PRESSED STEEL**
 WHEEL: **RUBBER**
 ON **STEEL DISK CENTRE**
 BEARING: **ROLLER**



LIGHT / MEDIUM



DRBS										
SWIVEL										
80DR4BSB	80	30		105x85	80x60	9	37.5	106	65	
100DR4BSB	100	32		105x85	80x60	9	40	128	80	
125DR4BSB	125	37		105x85	80x60	9	47	152	100	
★ 125DR4BSBLP	125	37		135x110	105x80	11	53	157	100	
160DR4BSB	160	40		135x105	105x80	11	65	195	175	
200DR4BSB	200	50		135x105	105x80	11	68	237	205	



DRBS										
FIXED										
80DR8BSB	80	30		105x85	80x60	9		106	65	
100DR8BSB	100	32		105x85	80x60	9		128	80	
125DR8BSB	125	37		105x85	80x60	9		152	100	
★ 125DR8BSBLP	125	37		135x110	105x80	11		157	100	
160DR8BSB	160	40		135x105	105x80	11		195	175	
200DR8BSB	200	50		135x105	105x80	11		237	205	



DRBS										
BRAKED										
80DR4BSBSWB	80	30		105x85	80x60	9	37.5	106	65	
100DR4BSBSWB	100	32		105x85	80x60	9	40	128	80	
125DR4BSBSWB	125	37		105x85	80x60	9	47	152	100	
★ 125DR4BSBSWBLP	125	37		135x110	105x80	11	53	157	100	
160DR4BSBSWB	160	40		135x105	105x80	11	65	195	175	
200DR4BSBSWB	200	50		135x105	105x80	11	68	237	205	



DRBS										
BOLT HOLE										
80DRBH12BSB	80	30					12.1	37.5	106	65
100DRBH12BSB	100	32					12.1	40	128	80
125DRBH12BSB	125	37					12.1	47	152	100
160DRBH12BSB	160	40					12.1	65	195	175
200DRBH12BSB	200	50					12.1	68	237	205



DRBS										
BOLT HOLE BRAKED										
80DRBH12BSBSWB	80	30					12.1	37.5	106	65
100DRBH12BSBSWB	100	32					12.1	40	128	80
125DRBH12BSBSWB	125	37					12.1	47	152	100
160DRBH12BSBSWB	160	40					12.1	65	195	175
200DRBH12BSBSWB	200	50					12.1	68	237	205

⚡ *Anti Static. Available on request. 160mm and 200mm ONLY.

EXPANDERS



★ LARGE PLATE OPTION AVAILABLE

INDUSTRIAL

SERIES: DRGR

BRACKET: **PRESSED STEEL**
 WHEEL: **GREY NON-MARKING**
RUBBER ON PLASTIC CENTRE
 BEARING: **ROLLER**

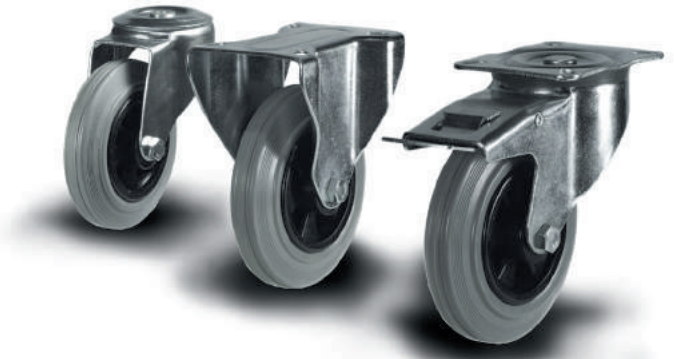

LIGHT / MEDIUM



DRGR										
SWIVEL										KG
80DR4GRB	80	30		105x85	80x60	9	37.5	106	65	
100DR4GRB	100	32		105x85	80x60	9	40	128	75	
125DR4GRB	125	37		105x85	80x60	9	47	152	100	
★ 125DR4GRBLP	125	37		135x110	105x80	11	53	157	100	
160DR4GRB	160	40		135x105	105x80	11	65	195	175	
200DR4GRB	200	50		135x105	105x80	11	68	237	205	



DRGR										
FIXED										KG
80DR8GRB	80	30		105x85	80x60	9		106	65	
100DR8GRB	100	32		105x85	80x60	9		128	75	
125DR8GRB	125	37		105x85	80x60	9		152	100	
★ 125DR8GRBLP	125	37		135x110	105x80	11		157	100	
160DR8GRB	160	40		135x105	105x80	11		195	175	
200DR8GRB	200	50		135x105	105x80	11		237	205	



DRGR										
BRAKED										KG
80DR4GRBSWB	80	30		105x85	80x60	9	37.5	106	65	
100DR4GRBSWB	100	32		105x85	80x60	9	40	128	75	
125DR4GRBSWB	125	37		105x85	80x60	9	47	152	100	
★ 125DR4GRBSWBLP	125	37		135x110	105x80	11	37	157	100	
160DR4GRBSWB	160	40		135x105	105x80	11	65	195	175	
200DR4GRBSWB	200	50		135x105	105x80	11	68	237	205	



DRGR										
BOLT HOLE										KG
80DRBH12GRB	80	30					12.1	37.5	106	65
100DRBH12GRB	100	32					12.1	40	128	75
125DRBH12GRB	125	37					12.1	47	152	100
160DRBH12GRB	160	40					12.1	65	195	175
200DRBH12GRB	200	50					12.1	68	237	205



DRGR										
BOLT HOLE BRAKED										KG
80DRBH12GRBSWB	80	30					12.1	37.5	106	65
100DRBH12GRBSWB	100	32					12.1	40	128	75
125DRBH12GRBSWB	125	37					12.1	47	152	100
160DRBH12GRBSWB	160	40					12.1	65	195	175
200DRBH12GRBSWB	200	50					12.1	68	237	205

EXPANDERS



★ LARGE PLATE OPTION AVAILABLE

INDUSTRIAL

SERIES: DRTPR

BRACKET: **PRESSED STEEL**
 WHEEL: **SYNTHETIC NON-MARKING**
 GREY RUBBER ON PLASTIC CENTRE
 BEARING: **PLAIN**



LIGHT / MEDIUM



DRTPR										
SWIVEL										
80DR4TPR	80	32		105x85	80x60	9	37.5	106	60	
100DR4TPR	100	32		105x85	80x60	9	40	128	80	
125DR4TPR	125	32		105x85	80x60	9	47	152	100	
160DR4TPRBIGBOX	160	38		135x105	105x80	11	65	195	140	
200DR4TPRBIGBOX	200	42		135x105	105x80	11	68	237	200	



DRTPR									
FIXED									
80DR8TPR	80	32		105x85	80x60	9		106	60
100DR8TPR	100	32		105x85	80x60	9		128	80
125DR8TPR	125	32		105x85	80x60	9		152	100
160DR8TPRBIGBOX	160	38		135x105	105x80	11		195	140
200DR8TPRBIGBOX	200	42		135x105	105x80	11		237	200



DRTPR									
BRAKED									
80DR4TPRSWB	80	32		105x85	80x60	9	37.5	106	60
100DR4TPRSWB	100	32		105x85	80x60	9	40	128	80
125DR4TPRSWB	125	32		105x85	80x60	9	47	152	100
160DR4TPRBIGSWBBOX	160	38		135x105	105x80	11	65	195	140
200DR4TPRBIGSWBBOX	200	42		135x105	105x80	11	68	237	200



DRTPR									
BOLT HOLE									
80DRBH12TPR	80	32				12.1	37.5	106	60
100DRBH12TPR	100	32				12.1	40	128	80
125DRBH12TPR	125	32				12.1	47	152	100
160DRBH12TPRBIGBOX	160	38				12.1	65	195	140
200DRBH12TPRBIGBOX	200	42				12.1	68	237	200



DRTPR									
BOLT HOLE BRAKED									
80DRBH12TPRSWB	80	32				12.1	37.5	106	60
100DRBH12TPRSWB	100	32				12.1	40	128	80
125DRBH12TPRSWB	125	32				12.1	47	152	100
160DRBH12TPRBIGSWBBOX	160	38				12.1	65	195	140
200DRBH12TPRBIGSWBBOX	200	42				12.1	68	237	200

*Anti Static. Available on request. 100mm and 125mm ONLY.

EXPANDERS



INDUSTRIAL

SERIES: DRBN

BRACKET: **PRESSED STEEL**
 WHEEL: **ELASTIC NON-MARKING
 RUBBER ON NYLON CENTRE**
 BEARING: **ROLLER/BALL BEARING**



LIGHT / MEDIUM



DRBN SWIVEL										
80DR4BNB	80	34			105x85	80x60	9	37.5	106	150
100DR4BNB	100	34			105x85	80x60	9	40	128	180
125DR4BNB	125	36			105x85	80x60	9	47	152	250
★ 125DR4BNBLP	125	36			135x110	105x80	11	53	157	250
160DR4BNB	160	45			135x105	105x80	11	65	195	350
200DR4BNB	200	45			135x105	105x80	11	68	237	350



DRBN FIXED										
80DR8BNB	80	34			105x85	80x60	9		106	150
100DR8BNB	100	34			105x85	80x60	9		128	180
125DR8BNB	125	36			105x85	80x60	9		152	250
★ 125DR8BNBLP	125	36			135x110	105x80	11		157	250
160DR8BNB	160	45			135x105	105x80	11		195	350
200DR8BNB	200	45			135x105	105x80	11		237	350

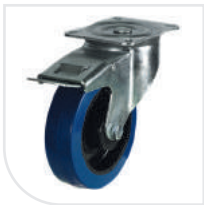

DRBN BRAKED										
80DR4BNBSWB	80	34			105x85	80x60	9	37.5	106	150
100DR4BNBSWB	100	34			105x85	80x60	9	40	128	180
125DR4BNBSWB	125	36			105x85	80x60	9	47	152	250
★ 125DR4BNBSWBLP	125	36			135x110	105x80	11	53	157	250
160DR4BNBSWB	160	45			135x105	105x80	11	65	195	350
200DR4BNBSWB	200	45			135x105	105x80	11	68	237	350



DRBN BOLT HOLE										
80DRBH12BNB	80	34						12.1	37.5	106
100DRBH12BNB	100	34						12.1	40	128
125DRBH12BNB	125	36						12.1	47	152
160DRBH12BNB	160	45						12.1	65	195
200DRBH12BNB	200	45						12.1	68	237



DRBN BOLT HOLE BRAKED										
80DRBH12BNBSWB	80	34						12.1	37.5	106
100DRBH12BNBSWB	100	34						12.1	40	128
125DRBH12BNBSWB	125	36						12.1	47	152
160DRBH12BNBSWB	160	45						12.1	65	195
200DRBH12BNBSWB	200	45						12.1	68	237

BNBJ WHEEL OPTION - CAN BE PROVIDED IN CERTAIN SIZES



★ LARGE PLATE OPTION AVAILABLE

INDUSTRIAL

SERIES: DREA

BRACKET: **PRESSED STEEL**
 WHEEL: **ELASTIC RUBBER**
 ON **ALUMINIUM CENTRE**
 BEARING: **BALL BEARING**



LIGHT / MEDIUM



DREA										
SWIVEL										KG
80DR4EABJ	80	36			105x85	80x60	9	37.5	106	100
100DR4EABJ	100	40			105x85	80x60	9	40	128	180
125DR4EABJ	125	38			105x85	80x60	9	47	152	200
★ 125DR4EABJLP	125	38			135x110	105x80	11	53	157	200
150DR4EABJ	150	50			135x105	105x80	11	65	185	300
160DR4EABJ	160	50			135x105	105x80	11	65	195	350
200DR4EABJ	200	50			135x105	105x80	11	68	237	350



DREA										
FIXED										KG
80DR8EABJ	80	36			105x85	80x60	9		106	100
100DR8EABJ	100	40			105x85	80x60	9		128	180
125DR8EABJ	125	38			105x85	80x60	9		152	200
★ 125DR8EABJLP	125	38			135x110	105x80	11		157	200
150DR8EABJ	150	50			135x105	105x80	11		185	300
160DR8EABJ	160	50			135x105	105x80	11		195	350
200DR8EABJ	200	50			135x105	105x80	11		237	350



DREA										
BRAKED										KG
80DR4EABJSWB	80	36			105x85	80x60	9	37.5	106	100
100DR4EABJSWB	100	40			105x85	80x60	9	40	128	180
125DR4EABJSWB	125	38			105x85	80x60	9	47	152	200
★ 125DR4EABJSWBLP	125	38			135x110	105x80	11	53	157	200
150DR4EABJSWB	150	50			135x105	105x80	11	65	185	300
160DR4EABJSWB	160	50			135x105	105x80	11	65	195	350
200DR4EABJSWB	200	50			135x105	105x80	11	68	237	350



DREA										
BOLT HOLE										KG
80DRBH12EABJ	80	36					12.1	37.5	106	100
100DRBH12EABJ	100	40					12.1	40	128	180
125DRBH12EABJ	125	38					12.1	47	152	200
150DRBH12EABJ	150	50					12.1	65	185	300
160DRBH12EABJ	160	50					12.1	65	195	350
200DRBH12EABJ	200	50					12.1	68	237	350



DREA										
BOLT HOLE BRAKED										KG
80DRBH12EABJSWB	80	36					12.1	37.5	106	100
100DRBH12EABJSWB	100	40					12.1	40	128	180
125DRBH12EABJSWB	125	38					12.1	47	152	200
150DRBH12EABJSWB	150	50					12.1	65	185	300
160DRBH12EABJSWB	160	50					12.1	65	195	350
200DRBH12EABJSWB	200	50					12.1	68	237	350



★ LARGE PLATE OPTION AVAILABLE

INDUSTRIAL

SERIES: DRRT

BRACKET: **PRESSED STEEL**
 WHEEL: **ELASTIC RUBBER ON**
CAST IRON CENTRE
 BEARING: **BALL BEARING**



LIGHT / MEDIUM



DRRT SWIVEL									
★ 125DR4RTBJLP	125	38		135x110	105x80	11	53	157	190
150DR4RTBJ	150	50		135x105	105x80	11	65	185	350
200DR4RTBJ	200	50		135x105	105x80	11	68	237	350



DRRT FIXED									
★ 125DR8RTBJP	125	38		135x110	105x80	11		157	190
150DR8RTBJ	150	50		135x105	105x80	11		185	350
200DR8RTBJ	200	50		135x105	105x80	11		237	350



DRRT BRAKED									
★ 125DR4RTBJSWBLP	125	38		135x110	105x80	11	53	157	190
150DR4RTBJSWB	150	50		135x105	105x80	11	65	185	350
200DR4RTBJSWB	200	50		135x105	105x80	11	68	237	350



DRRT BOLT HOLE									
150DRBH12RTBJ	150	50				12.1	65	185	350
200DRBH12RTBJ	200	50				12.1	68	237	350



DRRT BOLT HOLE BRAKED									
150DRBH12RTBJSWB	150	50				12.1	65	185	350
200DRBH12RTBJSWB	200	50				12.1	68	237	350

EXPANDERS



★ LARGE PLATE OPTION AVAILABLE

INDUSTRIAL

SERIES: DRCI

BRACKET: **PRESSED STEEL**
 WHEEL: **CAST IRON**
 BEARING: **ROLLER / BALL BEARING**



LIGHT / MEDIUM



DRCI SWIVEL										
100DR4CIB	100	38		105x85	80x60	9	40	128	220	
125DR4CIBJ	125	35		105x85	80x60	9	47	152	270	
★ 125DR4CIBJLP	125	35		135x110	105x80	11	53	157	400	
150DR4CIBJ	150	45		135x105	105x80	11	65	185	350	
200DR4CIBJ	200	45		135x105	105x80	11	68	237	350	



DRCI FIXED									
100DR8CIB	100	38		105x85	80x60	9		128	220
125DR8CIBJ	125	35		105x85	80x60	9		152	270
★ 125DR8CIBJLP	125	35		135x110	105x80	11		157	400
150DR8CIBJ	150	45		135x105	105x80	11		185	350
200DR8CIBJ	200	45		135x105	105x80	11		237	350



DRCI BRAKED									
100DR4CIBSWB	100	38		105x85	80x60	9	40	128	220
125DR4CIBJSWB	125	35		105x85	80x60	9	47	152	270
★ 125DR4CIBJSWB LP	125	35		135x110	105x80	11	53	157	400
150DR4CIBJSWB	150	45		135x105	105x80	11	65	185	350
200DR4CIBJSWB	200	45		135x105	105x80	11	68	237	350



DRCI BOLT HOLE									
100DRBH12CIB	100	38				12.1	40	128	220
125DRBH12CIBJ	125	35				12.1	47	152	270
150DRBH12CIBJ	150	45				12.1	65	185	350
200DRBH12CIBJ	200	45				12.1	68	237	350



DRCI BOLT HOLE BRAKED									
100DRBH12CIBSWB	100	38				12.1	40	128	220
125DRBH12CIBJSWB	125	35				12.1	47	152	270
150DRBH12CIBJSWB	150	45				12.1	65	185	350
200DRBH12CIBJSWB	200	45				12.1	68	237	350

EXPANDERS



★ LARGE PLATE OPTION AVAILABLE

INDUSTRIAL

SERIES: LVHT/G/BJG

BRACKET: **PRESSED STEEL**
 WHEEL: **HIGH TEMPERATURE RESISTANT**
 WHEELS 220 °C, 260 °C OR 280 °C
 BEARING: **PLAIN / BALL BEARING**



LIGHT / MEDIUM



LVHT/G SWIVEL									
100LV4HT 220	100	38		105x85	80x60	9	40	128	150
100LV4HTG 280	100	38		105x85	80x60	9	40	128	200



LVHT/G FIXED									
100LV8HT 220	100	38		105x85	80x60	9		128	150
100LV8HTG 280	100	38		105x85	80x60	9		128	200



LVHT/G BOLT HOLE										
100LVBH12HT 220	100	38					12.1	40	128	150
100LVBH12HTG 280	100	38					12.1	40	128	200



LVHTBJG SWIVEL									
80LV4HT 260	80	30		105x85	80x60	9	40	106	200
80LV4HTBJG 260	80	30		105x85	80x60	9	40	106	200
100LV4HT 260	100	32		105x85	80x60	9	40	128	220
100LV4HTBJG 260	100	32		105x85	80x60	9	40	128	220
125LV4HT 260	125	40		105x85	80x60	9	40	155	250
125LV4HTBJG 260	125	40		105x85	80x60	9	40	155	250



LVHTBJG FIXED									
80LV8HT 260	80	30		105x85	80x60	9		106	200
80LV8HTBJG 260	80	30		105x85	80x60	9		106	200
100LV8HT 260	100	32		105x85	80x60	9		128	220
100LV8HTBJG 260	100	32		105x85	80x60	9		128	220
125LV8HT 260	125	40		105x85	80x60	9		155	250
125LV8HTBJG 260	125	40		105x85	80x60	9		155	250



LVHTBJG BOLT HOLE										
80LVBH12HT 260	80	30					12.1	40	106	200
80LVBH12HTBJG 260	80	30					12.1	40	106	200
100LVBH12HT 260	100	32					12.1	40	128	220
100LVBH12HTBJG 260	100	32					12.1	40	128	220
125LVBH12HT 260	125	40					12.1	40	155	250
125LVBH12HTBJG 260	125	40					12.1	40	155	250

260°C CONSTANT (280°C SHORT PERIODS) (LVHTBJG ONLY)



INDUSTRIAL

SERIES: DRPNO

BRACKET: **PRESSED STEEL**
 WHEEL: **POLYURETHANE**
 ON **NYLON** CENTRE
 BEARING: **PLAIN**

LIGHT / MEDIUM



DRPNO										
SWIVEL										
80DR4PNO	80	30		105x85	80x60	9	37.5	106	100	
100DR4PNO	100	30		105x85	80x60	9	40	128	150	
125DR4PNO	125	35		105x85	80x60	9	47	152	200	
★ 125DR4PNOLP	125	35		135x110	105x80	11	53	157	200	
150DR4PNO	150	40		135x105	105x80	11	65	185	280	
160DR4PNO	160	38		135x105	105x80	11	65	195	250	
200DR4PNO	200	50		135x105	105x80	11	68	237	350	



DRPNO									
FIXED									
80DR8PNO	80	30		105x85	80x60	9		106	100
100DR8PNO	100	30		105x85	80x60	9		128	150
125DR8PNO	125	35		105x85	80x60	9		152	200
★ 125DR8PNOLP	125	35		135x110	105x80	11		157	200
150DR8PNO	150	40		135x105	105x80	11		185	280
160DR8PNO	160	38		135x105	105x80	11		195	250
200DR8PNO	200	50		135x105	105x80	11		237	350



DRPNO									
BRAKED									
80DR4PNOSWB	80	30		105x85	80x60	9	37.5	106	100
100DR4PNOSWB	100	30		105x85	80x60	9	40	128	150
125DR4PNOSWB	125	35		105x85	80x60	9	47	152	200
★ 125DR4PNOSWBLP	125	35		135x110	105x80	11	53	157	200
150DR4PNOSWB	150	40		135x105	105x80	11	65	185	280
160DR4PNOSWB	160	38		135x105	105x80	11	65	195	250
200DR4PNOSWB	200	50		135x105	105x80	11	68	237	350



DRPNO									
BOLT HOLE									
80DRBH12PNO	80	30					12.1	37.5	106
100DRBH12PNO	100	30					12.1	40	128
125DRBH12PNO	125	35					12.1	47	152
150DRBH12PNO	150	40					12.1	65	185
160DRBH12PNO	160	38					12.1	65	195
200DRBH12PNO	200	50					12.1	68	237



DRPNO									
BOLT HOLE BRAKED									
80DRBH12PNOSWB	80	30					12.1	37.5	106
100DRBH12PNOSWB	100	30					12.1	40	128
125DRBH12PNOSWB	125	35					12.1	47	152
150DRBH12PNOSWB	150	40					12.1	65	185
160DRBH12PNOSWB	160	38					12.1	65	195
200DRBH12PNOSWB	200	50					12.1	68	237



★ LARGE PLATE OPTION AVAILABLE

INDUSTRIAL

SERIES: DRPNR

BRACKET: **PRESSED STEEL**
 WHEEL: **POLYURETHANE**
 ON **NYLON CENTRE**
 BEARING: **ROLLER**



LIGHT / MEDIUM



DRPNR										
SWIVEL										
100DR4PNRB	100	34			105x85	80x60	9	40	128	200
125DR4PNRB	125	40			105x85	80x60	9	47	152	260
★ 125DR4PNRBLP	125	40			135x110	105x80	11	53	157	260



DRPNR										
FIXED										
100DR8PNRB	100	34			105x85	80x60	9		128	200
125DR8PNRB	125	40			105x85	80x60	9		152	260
★ 125DR8PNRBLP	125	40			135x110	105x80	11		157	260



DRPNR										
BRAKED										
100DR4PNRBSWB	100	34			105x85	80x60	9	40	128	200
125DR4PNRBSWB	125	40			105x85	80x60	9	47	152	260
★ 125DR4PNRBSWBLP	125	40			135x110	105x80	11	53	157	260



DRPNR											
BOLT HOLE											
100DRBH12PNRB	100	34						12.1	40	128	200
125DRBH12PNRB	125	40						12.1	47	152	260



DRPNR											
BOLT HOLE BRAKED											
100DRBH12PNRBSWB	100	34						12.1	40	128	200
125DRBH12PNRBSWB	125	40						12.1	47	152	260

EXPANDERS



★ LARGE PLATE OPTION AVAILABLE



INDUSTRIAL

SERIES: DREPN

BRACKET: **PRESSED STEEL**
 WHEEL: **ELASTIC POLYURETHANE**
 ON **NYLON CENTRE**
 BEARING: **PLAIN**

LIGHT / MEDIUM



DREPN	SWIVEL									
80DR4EPN	80	32								
100DR4EPN	100	32								
125DR4EPN	125	32								
★ 125DR4EPNLP	125	32								
150DR4EPN	150	42								
200DR4EPN	200	50								



DREPN	FIXED								
80DR8EPN	80	32							
100DR8EPN	100	32							
125DR8EPN	125	32							
★ 125DR8EPNLP	125	32							
150DR8EPN	150	42							
200DR8EPN	200	50							



DREPN	BRAKED								
80DR4EPNSWB	80	32							
100DR4EPNSWB	100	32							
125DR4EPNSWB	125	32							
★ 125DR4EPNSWBLP	125	32							
150DR4EPNSWB	150	42							
200DR4EPNSWB	200	50							



DREPN	BOLT HOLE								
80DRBH12EPN	80	32							
100DRBH12EPN	100	32							
125DRBH12EPN	125	32							
150DRBH12EPN	150	42							
200DRBH12EPN	200	50							



DREPN	BOLT HOLE BRAKED								
80DRBH12EPNSWB	80	32							
100DRBH12EPNSWB	100	32							
125DRBH12EPNSWB	125	32							
150DRBH12EPNSWB	150	42							
200DRBH12EPNSWB	200	50							



★ LARGE PLATE OPTION AVAILABLE

INDUSTRIAL

SERIES: DRPN

BRACKET: **PRESSED STEEL**
 WHEEL: **POLYURETHANE**
 ON **NYLON CENTRE**
 BEARING: **BALL BEARING**



LIGHT / MEDIUM



DRPN SWIVEL										
100DR4PNBJ	100	38			105x85	80x60	9	40	128	220
125DR4PNBJ	125	38			105x85	80x60	9	47	152	270
★ 125DR4PNBJLP	125	38			135x110	105x80	11	53	157	280
150DR4PNBJ	150	50			135x105	105x80	11	65	185	350
200DR4PNBJ	200	50			135x105	105x80	11	68	237	350



DRPN FIXED										
100DR8PNBJ	100	38			105x85	80x60	9		128	220
125DR8PNBJ	125	38			105x85	80x60	9		152	270
★ 125DR8PNBJLP	125	38			135x110	105x80	11		157	280
150DR8PNBJ	150	50			135x105	105x80	11		185	350
200DR8PNBJ	200	50			135x105	105x80	11		237	350



DRPN BRAKED										
100DR4PNBJSWB	100	38			105x85	80x60	9	40	128	220
125DR4PNBJSWB	125	38			105x85	80x60	9	47	152	270
★ 125DR4PNBJSWBLP	125	38			135x110	105x80	11	53	157	280
150DR4PNBJSWB	150	50			135x105	105x80	11	65	185	350
200DR4PNBJSWB	200	50			135x105	105x80	11	68	237	350



DRPN BOLT HOLE										
100DRBH12PNBJ	100	38						12.1	40	128
125DRBH12PNBJ	125	38						12.1	47	152
150DRBH12PNBJ	150	50						12.1	65	185
200DRBH12PNBJ	200	50						12.1	68	237



DRPN BOLT HOLE BRAKED										
100DRBH12PNBJSWB	100	38						12.1	40	128
125DRBH12PNBJSWB	125	35						12.1	47	152
150DRBH12PNBJSWB	150	50						12.1	65	185
200DRBH12PNBJSWB	200	50						12.1	68	237



★ LARGE PLATE OPTION AVAILABLE

INDUSTRIAL

SERIES: DRPX

BRACKET: **PRESSED STEEL**
 WHEEL: **POLYURETHANE**
 ON **NYLON CENTRE**
 BEARING: **BALL BEARING**



LIGHT / MEDIUM



DRPX SWIVEL									
150DR4PXB	150	50		135x105	105x80	11	65	185	350
200DR4PXB	200	50		135x105	105x80	11	68	237	350



DRPX FIXED								
150DR8PXB	150	50		135x105	105x80	11	185	350
200DR8PXB	200	50		135x105	105x80	11	237	350



DRPX BRAKED									
150DR4PXBJSWB	150	50		135x105	105x80	11	65	185	350
200DR4PXBJSWB	200	50		135x105	105x80	11	68	237	350



DRPX BOLT HOLE									
150DRBH12PXB	150	50				12.1	65	185	350
200DRBH12PXB	200	50				12.1	68	237	350



DRPX BOLT HOLE BRAKED									
150DRBH12PXBJSWB	150	50				12.1	65	185	350
200DRBH12PXBJSWB	200	50				12.1	68	237	350



INDUSTRIAL

SERIES: DROPU

BRACKET: **PRESSED STEEL**
 WHEEL: **POLYURETHANE**
 ON **NYLON CENTRE**
 BEARING: **BALL BEARING**



LIGHT / MEDIUM



DROPU										
SWIVEL										
150DR40PUBJ	100	50		135x105	105x80	11	65	185		300
200DR40PUBJ	200	50		135x105	105x80	11	68	237		350



DROPU										
FIXED										
150DR80PUBJ	150	50		135x105	105x80	11		185		300
200DR80PUBJ	200	50		135x105	105x80	11		237		350



DROPU										
BRAKED										
150DR40PUBJSWB	150	50		135x105	105x80	11	65	185		300
200DR40PUBJSWB	200	50		135x105	105x80	11	68	237		350



DROPU										
BOLT HOLE										
150DRBH120PUBJ	150	50					12.1	65	185	300
200DRBH120PUBJ	200	50					12.1	68	237	350



DROPU										
BOLT HOLE BRAKED										
150DRBH120PUBJSWB	150	50					12.1	65	185	300
200DRBH120PUBJSWB	200	50					12.1	68	237	350



INDUSTRIAL

SERIES: DRPT

BRACKET: **PRESSED STEEL**
 WHEEL: **POLYURETHANE**
 ON **CAST IRON** CENTRE
 BEARING: **BALL BEARING**



LIGHT / MEDIUM



DRPT SWIVEL										
100DR4PTBJ	100	38		105x85	80x60	9	40	128	220	
125DR4PTBJ	125	38		105x85	80x60	9	47	152	270	
★ 125DR4PTBJLP	125	38		135x110	105x80	12	38	157	450	
150DR4PTBJ	150	50		135x105	105x80	11	65	185	350	
200DR4PTBJ	200	50		135x105	105x80	11	68	237	350	



DRPT FIXED									
100DR8PTBJ	100	38		105x85	80x60	9		128	220
125DR8PTBJ	125	38		105x85	80x60	9		152	270
★ 125DR8PTBJLP	125	38		135x110	105x80	12		157	450
150DR8PTBJ	150	50		135x105	105x80	11		185	350
200DR8PTBJ	200	50		135x105	105x80	11		237	350



DRPT BRAKED									
100DR4PTBJSWB	100	38		105x85	80x60	9	40	128	220
125DR4PTBJSWB	125	38		105x85	80x60	9	47	152	270
★ 125DR4PTBJSWBLP	125	38		135x110	105x80	12	38	157	450
150DR4PTBJSWB	150	50		135x105	105x80	11	65	185	350
200DR4PTBJSWB	200	50		135x105	105x80	11	68	237	350



DRPT BOLT HOLE									
100DRBH12PTBJ	100	38					12.1	40	128
125DRBH12PTBJ	125	38					12.1	47	152
150DRBH12PTBJ	150	50					12.1	65	185
200DRBH12PTBJ	200	50					12.1	68	237



DRPT BOLT HOLE BRAKED									
100DRBH12PTBJSWB	100	38					12.1	40	128
125DRBH12PTBJSWB	125	38					12.1	47	152
150DRBH12PTBJSWB	150	50					12.1	65	185
200DRBH12PTBJSWB	200	50					12.1	68	237

EXPANDERS



★ LARGE PLATE OPTION AVAILABLE

INDUSTRIAL

SERIES: DRPTA

BRACKET: **PRESSED STEEL**
 WHEEL: **POLYURETHANE ON ALUMINIUM CENTRE**
 BEARING: **BALL BEARING**



LIGHT / MEDIUM



DRPTA SWIVEL										
80DR4PTABJ	80	30		105x85	80x60	9	37.5	106	180	180
100DR4PTABJ	100	40		105x85	80x60	9	40	128	220	220
125DR4PTABJ	125	40		105x85	80x60	9	47	152	270	270
150DR4PTABJ	150	50		135x105	105x80	11	65	185	350	350
160DR4PTABJ	160	50		135x105	105x80	11	65	190	350	350
200DR4PTABJ	200	50		135x105	105x80	11	68	237	350	350



DRPTA FIXED									
80DR8PTABJ	80	30		105x85	80x60	9		106	180
100DR8PTABJ	100	40		105x85	80x60	9		128	220
125DR8PTABJ	125	40		105x85	80x60	9		152	270
150DR8PTABJ	150	50		135x105	105x80	11		185	350
160DR8PTABJ	160	50		135x105	105x80	11		190	350
200DR8PTABJ	200	50		135x105	105x80	11		237	350



DRPTA BRAKED									
80DR4PTABJSWB	80	30		105x85	80x60	9	37.5	106	180
100DR4PTABJSWB	100	40		105x85	80x60	9	40	128	220
125DR4PTABJSWB	125	40		105x85	80x60	9	47	152	270
150DR4PTABJSWB	150	50		135x105	105x80	11	65	185	350
160DR4PTABJSWB	160	50		135x105	105x80	11	65	190	350
200DR4PTABJSWB	200	50		135x105	105x80	11	68	237	350



DRPTA BOLT HOLE									
80DRBH12PTABJ	80	30					12.1	37.5	106
100DRBH12PTABJ	100	40					12.1	40	128
125DRBH12PTABJ	125	40					12.1	47	152
150DRBH12PTABJ	150	50					12.1	65	185
160DRBH12PTABJ	160	50					12.1	65	190
200DRBH12PTABJ	200	50					12.1	68	237



DRPTA BOLT HOLE BRAKED									
80DRBH12PTABJSWB	80	30					12.1	37.5	106
100DRBH12PTABJSWB	100	40					12.1	40	128
125DRBH12PTABJSWB	125	40					12.1	47	152
150DRBH12PTABJSWB	150	50					12.1	65	185
160DRBH12PTABJSWB	160	50					12.1	65	190
200DRBH12PTABJSWB	200	50					12.1	68	237



WASTE CONTAINER

SERIES: DRWCPS/BS

BRACKET: PRESSED STEEL
 WHEEL: RUBBER TYRE ON STEEL DISK
 CENTRE & RUBBER TYRE ON PLASTIC
 BEARING: ROLLER



MEDIUM

	DRWCPS/BS										
	SWIVEL										
	PS	160DRWC4PSB	160	40		135x110	105x80	11	55	196	175
		200DRWC4PSB	200	50		135x110	105x80	11	65	238	205
	BS	160DRWC4BSB	160	40		135x110	105x80	11	55	196	175
200DRWC4BSB		200	50		135x110	105x80	11	65	238	205	

	DRWCPS/BS										
	FIXED										
	PS	160DRWC8PSB	160	40		135x110	105x80	11		196	175
		200DRWC8PSB	200	50		135x110	105x80	11		238	205
	BS	160DRWC8BSB	160	40		135x110	105x80	11		196	175
200DRWC8BSB		200	50		135x110	105x80	11		238	205	

	DRWCPS/BS										
	SHORT BRAKE										
	PS	160DRWC4PSBSB	160	40		135x110	105x80	11	55	196	175
		200DRWC4PSBSB	200	50		135x110	105x80	11	65	238	205
	BS	160DRWC4BSBSB	160	40		135x110	105x80	11	55	196	175
200DRWC4BSBSB		200	50		135x110	105x80	11	65	238	205	

	DRWCPS/BS										
	LEADING BRAKE										
	PS	160DRWC4PSBSWB	160	40		135x110	105x80	11	55	196	175
		200DRWC4PSBSWB	200	50		135x110	105x80	11	65	238	205
	BS	160DRWC4BSBSWB	160	40		135x110	105x80	11	55	196	175
200DRWC4BSBSWB		200	50		135x110	105x80	11	65	238	205	



Directional Lock

WHEELIE BIN

	WPSNW						
	Nose Wheels						
	200WPSNW		200	50		22	205
	AXLE		552mm Shaft Length 21.5mm Diameter				

INDUSTRIAL

SERIES: SSDRLCTP

BRACKET: **STAINLESS STEEL**
 WHEEL: **SYNTHETIC NON MARKING**
 BEARING: **PLAIN**



MEDIUM



SSDRLCTP								
SWIVEL								KG
SS50DRL4CTP	50	20			60x60	43x43	6.3	24
SS75DRL4CTP	75	23			60x60	43x43	6.3	28
								69.5
								100
								80



SSDRLCTP								
FIXED								KG
SS50DRL8CTP	50	20			60x60	43x43	6.3	24
SS75DRL8CTP	75	23			60x60	43x43	6.3	28
								69.5
								69.5
								80



SSDRLCTP								
BRAKED								KG
SS50DRL4CTPSWB	50	20			60x60	43x43	6.3	24
SS75DRL4CTPSWB	75	23			60x60	43x43	6.3	28
								69.5
								100
								80



SSDRLCTP								
BOLT HOLE								KG
SS50DRLBH1OCTP	50	20					10.5	24
SS75DRLBH1OCTP	75	23					10.5	28
								68
								98
								40
								50



SSDRLCTP								
BOLT HOLE BRAKED								KG
SS50DRLBH1OCTPSWB	50	20					10.5	24
SS75DRLBH1OCTPSWB	75	23					10.5	28
								68
								98
								40
								50



DIFFERENT COLOUR WHEELS AVAILABLE

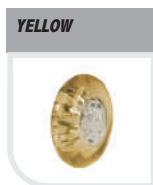



INDUSTRIAL

SERIES: SSDRLNY

BRACKET: **STAINLESS STEEL**
 WHEEL: **NYLON**
 BEARING: **PLAIN**

STAINLESS STEEL
INOX

MEDIUM



SSDRLNY									
SWIVEL									
SS50DRL4NY	50	20		60x60	43x43	6.3	24	69.5	40
SS75DRL4NY	75	25		60x60	43x43	6.3	28	100	50



SSDRLNY									
FIXED									
SS50DRL8NY	50	20		60x60	43x43	6.3		69.5	40
SS75DRL8NY	75	25		60x60	43x43	6.3		69.5	50



SSDRLNY									
BRAKED									
SS50DRL4NYSWB	50	20		60x60	43x43	6.3	24	69.5	40
SS75DRL4NYSWB	75	25		60x60	43x43	6.3	28	100	50



SSDRLNY									
BOLT HOLE									
SS50DRLBH10NY	50	20				10.5	24	68	40
SS75DRLBH10NY	75	25				10.5	28	98	50



SSDRLNY									
BOLT HOLE BRAKED									
SS50DRLBH10NYSWB	50	20				10.5	24	68	40
SS75DRLBH10NYSWB	75	25				10.5	28	98	50

STAINLESS STEEL
INOX

EXPANDERS

AVAILABLE

PAGE
148

INDUSTRIAL

SERIES: SSDRLTPR

BRACKET: STAINLESS STEEL
 WHEEL: SYNTHETIC NON-MARKING
 GREY RUBBER ON PLASTIC CENTRE
 BEARING: PLAIN

STAINLESS STEEL
INOX



MEDIUM



SSDRLTPR									
SWIVEL									
SS50DRL4TPR	50	20		60x60	43x43	6.3	24	69.5	40
SS75DRL4TPR	75	23		60x60	43x43	6.3	28	100	50



SSDRLTPR									
FIXED									
SS50DRL8TPR	50	20		60x60	43x43	6.3		69.5	40
SS75DRL8TPR	75	23		60x60	43x43	6.3		100	50



SSDRLTPR									
BRAKED									
SS50DRL4TPRSWB	50	20		60x60	43x43	6.3	24	69.5	40
SS75DRL4TPRSWB	75	23		60x60	43x43	6.3	28	100	50



SSDRLTPR									
BOLT HOLE									
SS50DRLBH10TPR	50	20				10.5	24	68	40
SS75DRLBH10TPR	75	23				10.5	28	98	50



SSDRLTPR									
BOLT HOLE BRAKED									
SS50DRLBH10TPRSWB	50	20				10.5	24	68	40
SS75DRLBH10TPRSWB	75	23				10.5	28	98	50

STAINLESS STEEL
INOX





INDUSTRIAL

SERIES: SSDRNY

BRACKET: **STAINLESS STEEL**
WHEEL: **NYLON**
BEARING: **PLAIN**

STAINLESS STEEL
INOX

MEDIUM



SSDRNY SWIVEL										
SS80DR4NY	80	35		105x85	80x60	9	37.5	106	200	200
SS100DR4NY	100	35		105x85	80x60	9	40	128	200	200
SS125DR4NY	125	35		105x85	80x60	9	47	152	270	270
SS160DR4NY	160	45		135x105	105x80	11	65	195	350	350
SS200DR4NY	200	50		135x105	105x80	11	68	237	350	350



SSDRNY FIXED									
SS80DR8NY	80	35		105x85	80x60	9		106	200
SS100DR8NY	100	35		105x85	80x60	9		128	200
SS125DR8NY	125	35		105x85	80x60	9		152	270
SS160DR8NY	160	45		135x105	105x80	11		195	350
SS200DR8NY	200	50		135x105	105x80	11		237	350



SSDRNY BRAKED									
SS80DR4NYSWB	80	35		105x85	80x60	9	37.5	106	200
SS100DR4NYSWB	100	35		105x85	80x60	9	40	128	200
SS125DR4NYSWB	125	35		105x85	80x60	9	47	152	270
SS160DR4NYSWB	160	45		135x105	105x80	11	65	195	350
SS200DR4NYSWB	200	50		135x105	105x80	11	68	237	350



SSDRNY BOLT HOLE									
SS80DRBH12NY	80	35				12.1	37.5	106	200
SS100DRBH12NY	100	35				12.1	40	128	200
SS125DRBH12NY	125	35				12.1	47	152	270



SSDRNY BOLT HOLE BRAKED									
SS80DRBH12NYSWB	80	35				12.1	37.5	106	200
SS100DRBH12NYSWB	100	35				12.1	40	128	200
SS125DRBH12NYSWB	125	35				12.1	47	152	270

STAINLESS STEEL
INOX



Only on 80, 100 and 125mm.

INDUSTRIAL

SERIES: SSDRGR

BRACKET: **STAINLESS STEEL**
 WHEEL: **GREY NON-MARKING**
 RUBBER ON PLASTIC CENTRE
 BEARING: **ROLLER**

STAINLESS STEEL
INOX



MEDIUM



SSDRGR										
SWIVEL										
SS80DR4GRB	80	30		105x85	80x60	9	37.5	106	65	
SS100DR4GRB	100	32		105x85	80x60	9	40	128	80	
SS125DR4GRB	125	37		105x85	80x60	9	47	152	100	
SS160DR4GRB	160	40		135x105	105x80	11	65	195	175	
SS200DR4GRB	200	50		135x105	105x80	11	68	237	205	



SSDRGR									
FIXED									
SS80DR8GRB	80	30		105x85	80x60	9		106	65
SS100DR8GRB	100	32		105x85	80x60	9		128	80
SS125DR8GRB	125	37		105x85	80x60	9		152	100
SS160DR8GRB	160	40		135x105	105x80	11		195	175
SS200DR8GRB	200	50		135x105	105x80	11		237	205



SSDRGR									
BRAKED									
SS80DR4GRBSWB	80	30		105x85	80x60	9	37.5	106	65
SS100DR4GRBSWB	100	32		105x85	80x60	9	40	128	80
SS125DR4GRBSWB	125	37		105x85	80x60	9	47	152	100
SS160DR4GRBSWB	160	40		135x105	105x80	11	65	195	175
SS200DR4GRBSWB	200	50		135x105	105x80	11	68	237	205



SSDRGR									
BOLT HOLE									
SS80DRBH12GRB	80	30				12.1	37.5	106	65
SS100DRBH12GRB	100	32				12.1	40	128	80
SS125DRBH12GRB	125	37				12.1	47	152	100



SSDRGR									
BOLT HOLE BRAKED									
SS80DRBH12GRBSWB	80	30				12.1	37.5	106	65
SS100DRBH12GRBSWB	100	32				12.1	40	128	80
SS125DRBH12GRBSWB	125	37				12.1	47	152	100

STAINLESS STEEL
INOX



INDUSTRIAL

SERIES: SSDRTPR

BRACKET: **STAINLESS STEEL**
 WHEEL: **SYNTHETIC NON-MARKING**
 GREY RUBBER ON PLASTIC CENTRE
 BEARING: **PLAIN**

STAINLESS STEEL
INOX



SSDRTPR										
SWIVEL										
SS80DR4TPR	80	32		105X85	80x60	9	37.5	106		60
SS100DR4TPR	100	32		105x85	80x60	9	40	128		80
SS125DR4TPR	125	32		105x85	80x60	9	47	152		100



SSDRTPR										
FIXED										
SS80DR8TPR	80	32		105X85	80x60	9		106		60
SS100DR8TPR	100	32		105x85	80x60	9		128		80
SS125DR8TPR	125	32		105x85	80x60	9		152		100



SSDRTPR										
BRAKED										
SS80DR4TPRSWB	80	32		105X85	80x60	9	37.5	106		60
SS100DR4TPRSWB	100	32		105x85	80x60	9	40	128		80
SS125DR4TPRSWB	125	32		105x85	80x60	9	47	152		100



SSDRTPR										
BOLT HOLE										
SS80DRBH12TPR	80	32					9	37.5	106	60
SS100DRBH12TPR	100	32					9	40	128	80
SS125DRBH12TPR	125	32					9	47	152	100



SSDRTPR										
BOLT HOLE BRAKED										
SS80DRBH12TPRSWB	80	32					9	37.5	106	60
SS100DRBH12TPRSWB	100	32					9	40	128	80
SS125DRBH12TPRSWB	125	32					9	47	152	100

STAINLESS STEEL
INOX

EXPANDERS



MEDIUM

INDUSTRIAL

SERIES: SSDRBN

BRACKET: STAINLESS STEEL
 WHEEL: ELASTIC RUBBER
 ON NYLON CENTRE NON-MARKING
 BEARING: ROLLER

STAINLESS STEEL
INOX



MEDIUM



SSDRBN										
SWIVEL										
SS80DR4BNB	80	34		105x85	80x60	9	37.5	106	150	
SS100DR4BNB	100	34		105x85	80x60	9	40	128	180	
SS125DR4BNB	125	36		105x85	80x60	9	47	152	250	
SS160DR4BNB	160	45		135x105	105x80	11	65	195	350	
SS200DR4BNB	200	45		135x105	105x80	11	68	237	350	



SSDRBN									
FIXED									
SS80DR8BNB	80	34		105x85	80x60	9		106	150
SS100DR8BNB	100	34		105x85	80x60	9		128	180
SS125DR8BNB	125	36		105x85	80x60	9		152	250
SS160DR8BNB	160	45		135x105	105x80	11		195	350
SS200DR8BNB	200	45		135x105	105x80	11		237	350



SSDRBN									
BRAKED									
SS80DR4BNBSWB	80	34		105x85	80x60	9	37.5	106	150
SS100DR4BNBSWB	100	34		105x85	80x60	9	40	128	180
SS125DR4BNBSWB	125	36		105x85	80x60	9	47	152	250
SS160DR4BNBSWB	160	45		135x105	105x80	11	65	195	350
SS200DR4BNBSWB	200	45		135x105	105x80	11	68	237	350



SSDRBN									
BOLT HOLE									
SS80DRBH12BNB	80	34				12.1	37.5	106	150
SS100DRBH12BNB	100	34				12.1	40	128	180
SS125DRBH12BNB	125	36				12.1	47	152	250



SSDRBN									
BOLT HOLE BRAKED									
SS80DRBH12BNBSWB	80	34				12.1	37.5	106	150
SS100DRBH12BNBSWB	100	34				12.1	40	128	180
SS125DRBH12BNBSWB	125	36				12.1	47	152	250

STAINLESS STEEL
INOX



INDUSTRIAL

SERIES: SSLVHT/G/BJG

BRACKET: STAINLESS STEEL
 WHEEL: HIGH TEMPERATURE RESISTANT
 WHEELS 220 °C, 260 °C OR 280 °C
 BEARING: PLAIN / BALL BEARING

STAINLESS STEEL
INOX



SSLVHT/G	SWIVEL									KG
SS100LV4HT 220	100	38		105x85	80x60	9	40	128	150	150
SS100LV4HTG 280	100	38		105x85	80x60	9	40	128	200	200



SSLVHT/G	FIXED									KG
SS100LV8HT 220	100	38		105x85	80x60	9		128	150	150
SS100LV8HTG 280	100	38		105x85	80x60	9		128	200	200



SSLVHT/G	BOLT HOLE									KG
SS100LVBH12HT 220	100	38				12.1	40	128	150	150
SS100LVBH12HTG 280	100	38				12.1	40	128	200	200



SSLVHTBJG	SWIVEL									KG
SS80LV4HT 260	80	30		105x85	80x60	9	40	106	200	200
SS80LV4HTBJG 260	80	30		105x85	80x60	9	40	106	200	200
SS100LV4HT 260	100	32		105x85	80x60	9	40	128	220	220
SS100LV4HTBJG 260	100	32		105x85	80x60	9	40	128	220	220
SS125LV4HT 260	125	40		105x85	80x60	9	40	155	250	250
SS125LV4HTBJG 260	125	40		105x85	80x60	9	40	155	250	250



SSLVHTBJG	FIXED									KG
SS80LV8HT 260	80	30		105x85	80x60	9		106	200	200
SS80LV8HTBJG 260	80	30		105x85	80x60	9		106	200	200
SS100LV8HT 260	100	32		105x85	80x60	9		128	220	220
SS100LV8HTBJG 260	100	32		105x85	80x60	9		128	220	220
SS125LV8HT 260	125	40		105x85	80x60	9		155	250	250
SS125LV8HTBJG 260	125	40		105x85	80x60	9		155	250	250



SSLVHTBJG	BOLT HOLE									KG
SS80LVBH12HT 260	80	30				12.1	40	106	200	200
SS80LVBH12HTBJG 260	80	30				12.1	40	106	200	200
SS100LVBH12HT 260	100	32				12.1	40	128	220	220
SS100LVBH12HTBJG 260	100	32				12.1	40	128	220	220
SS125LVBH12HT 260	125	40				12.1	40	155	250	250
SS125LVBH12HTBJG 260	125	40				12.1	40	155	250	250

260°C CONSTANT (280°C SHORT PERIODS)(SSLVHTBJG ONLY)

MEDIUM

INDUSTRIAL

SERIES: SSDRPNO

BRACKET: **STAINLESS STEEL**
 WHEEL: **POLYURETHANE**
 ON **NYLON CENTRE**
 BEARING: **PLAIN**

STAINLESS STEEL
INOX



MEDIUM



SSDRPNO SWIVEL										
SS80DR4PNO	80	30		105x85	80x60	9	37.5	106	100	
SS100DR4PNO	100	30		105x85	80x60	9	40	128	150	
SS125DR4PNO	125	35		105x85	80x60	9	47	152	200	
SS160DR4PNO	160	38		135x105	105x80	11	65	195	250	
SS200DR4PNO	200	50		135x105	105x80	11	68	237	350	



SSDRPNO FIXED									
SS80DR8PNO	80	30		105x85	80x60	9		106	100
SS100DR8PNO	100	30		105x85	80x60	9		128	150
SS125DR8PNO	125	35		105x85	80x60	9		152	200
SS160DR8PNO	160	38		135x105	105x80	11		195	250
SS200DR8PNO	200	50		135x105	105x80	11		237	350



SSDRPNO BRAKED									
SS80DR4PNOSWB	80	30		105x85	80x60	9	37.5	106	100
SS100DR4PNOSWB	100	30		105x85	80x60	9	40	128	150
SS125DR4PNOSWB	125	35		105x85	80x60	9	47	152	200
SS160DR4PNOSWB	160	38		135x105	105x80	11	65	195	250
SS200DR4PNOSWB	200	50		135x105	105x80	11	68	237	350



SSDRPNO BOLT HOLE									
SS80DRBH12PNO	80	30					12.1	37.5	106
SS100DRBH12PNO	100	30					12.1	40	128
SS125DRBH12PNO	125	35					12.1	47	152



SSDRPNO BOLT HOLE BRAKED									
SS80DRBH12PNOSWB	80	30					12.1	37.5	106
SS100DRBH12PNOSWB	100	30					12.1	40	128
SS125DRBH12PNOSWB	125	35					12.1	47	152

STAINLESS STEEL
INOX



Only 100mm.

INDUSTRIAL

SERIES: SSDREPN

BRACKET: **STAINLESS STEEL**
 WHEEL: **ELASTIC POLYURETHANE**
 ON **NYLON CENTRE**
 BEARING: **PLAIN**

STAINLESS STEEL
INOX



MEDIUM



SSDREPN									
SWIVEL									
SS80DR4EPN	80	32		105x85	80x60	9	37.5	106	100
SS100DR4EPN	100	32		105x85	80x60	9	40	128	150
SS125DR4EPN	125	32		105x85	80x60	9	47	152	175
SS150DR4EPN	150	42		135x105	105x80	11	65	190	200
SS200DR4EPN	200	50		135x105	105x80	11	68	237	250



SSDREPN									
FIXED									
SS80DR8EPN	80	32		105x85	80x60	9		106	100
SS100DR8EPN	100	32		105x85	80x60	9		128	150
SS125DR8EPN	125	32		105x85	80x60	9		152	175
SS150DR8EPN	150	42		135x105	105x80	11		190	200
SS200DR8EPN	200	50		135x105	105x80	11		237	250



SSDREPN									
BRAKED									
SS80DR4EPNSWB	80	32		105x85	80x60	9	37.5	106	100
SS100DR4EPNSWB	100	32		105x85	80x60	9	40	128	150
SS125DR4EPNSWB	125	32		105x85	80x60	9	47	152	175
SS200DR4EPNSWB	200	50		135x105	105x80	11	68	237	250



SSDREPN									
BOLT HOLE									
SS80DRBH12EPN	80	32					12.1	37.5	106
SS100DRBH12EPN	100	32					12.1	40	128
SS125DRBH12EPN	125	32					12.1	47	152



SSDREPN									
BOLT HOLE BRAKED									
SS80DRBH12EPNSWB	80	32					12.1	37.5	106
SS100DRBH12EPNSWB	100	32					12.1	40	128
SS125DRBH12EPNSWB	125	32					12.1	47	152

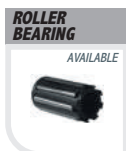

INDUSTRIAL

SERIES: DRH/GDHN

BRACKET: **HEAVY PRESSED STEEL**
 WHEEL: **NYLON**
 BEARING: **ROLLER AND BALL BEARING**



MEDIUM / HEAVY



DRHNY SWIVEL

	Ø	H	BEARING	WHEEL	WHEEL	WHEEL	WHEEL	WHEEL	WHEEL	KG
GOLD BRACKET										
125GDH4NYBJ	125	50	●●	135x110	105X80	12	55	166	700	
150GDH4NYBJ	150	45	●●●●	135x110	105x80	12	55	194	700	
200GDH4NYBJ	200	50	●●●●	135x110	105x80	12	55	239	800	
250GDH4NYBJ	250	60	●●●●	135x110	105x80	12	55	291	800	
100DRH4NYB	100	35		105x85	80x60	9	39	128	250	
100DRH4NYBJ	100	40	●●	105x85	80x60	9	39	128	350	
125DRH4NYB	125	35		105x85	80x60	9	44	152	270	
125DRH4NYBJ	125	35	●●	105x85	80x60	9	44	152	400	



DRHNY FIXED

	Ø	H	BEARING	WHEEL	WHEEL	WHEEL	WHEEL	WHEEL	WHEEL	KG
GOLD BRACKET										
125GDH8NYBJ	125	50	●●	135x110	105X80	12	55	166	700	
150GDH8NYBJ	150	45	●●●●	135x110	105x80	12	55	194	700	
200GDH8NYBJ	200	50	●●●●	135x110	105x80	12	55	239	800	
250GDH8NYBJ	250	60	●●●●	135x110	105x80	12	55	291	800	
100DRH8NYB	100	35		105x85	80x60	9		128	250	
100DRH8NYBJ	100	40	●●	105x85	80x60	9		128	350	
125DRH8NYB	125	35		105x85	80x60	9		152	270	
125DRH8NYBJ	125	35	●●	105x85	80x60	9		152	400	



DRHNY BRAKED

	Ø	H	BEARING	WHEEL	WHEEL	WHEEL	WHEEL	WHEEL	WHEEL	KG
GOLD BRACKET										
125GDH4NYBJSWB	125	50	●●	135x110	105X80	12	55	166	700	
150GDH4NYBJSWB	150	45	●●●●	135x110	105x80	12	55	194	700	
200GDH4NYBJSWB	200	50	●●●●	135x110	105x80	12	55	239	800	
250GDH4NYBJSWB	250	60	●●●●	135x110	105x80	12	55	291	800	
100DRH4NYBSWB	100	35		105x85	80x60	9	39	128	250	
100DRH4NYBJSWB	100	40	●●	105x85	80x60	9	39	128	350	
125DRH4NYBSWB	125	35		105x85	80x60	9	44	152	270	
125DRH4NYBJSWB	125	35	●●	105x85	80x60	9	44	152	400	



DRHNY BOLT HOLE

	Ø	H	BEARING	WHEEL	WHEEL	WHEEL	WHEEL	WHEEL	WHEEL	KG
100DRHBH12NYB	100	35					12.1	39	128	250
100DRHBH12NYBJ	100	40	●●				12.1	39	128	350
125DRHBH12NYB	125	35					12.1	44	152	270
125DRHBH12NYBJ	125	35	●●				12.1	44	152	400



DRHNY BOLT HOLE BRAKED

	Ø	H	BEARING	WHEEL	WHEEL	WHEEL	WHEEL	WHEEL	WHEEL	KG
100DRHBH12NYBSWB	100	35					12.1	39	128	250
100DRHBH12NYBJSWB	100	40	●●				12.1	39	128	350
125DRHBH12NYBSWB	125	35					12.1	44	152	270
125DRHBH12NYBJSWB	125	35	●●				12.1	44	152	400

EXPANDERS



AVAILABLE
PAGE 148

DIRECTIONAL LOCK



AVAILABLE

Only Gold swivel castors.



INDUSTRIAL

SERIES: DRH/GDHBN

BRACKET: **HEAVY PRESSED STEEL**
 WHEEL: **ELASTIC NON-MARKING RUBBER ON NYLON CENTRE**
 BEARING: **ROLLER / BALL BEARING**

MEDIUM / HEAVY



DRHBN SWIVEL										
GOLD BRACKET										
125GDH4BNBJ	125	50		135x110	105x80	12	55	166	310	
150GDH4BNBJ	150	50		135x110	105x80	12	55	194	350	
160GDH4BNB	160	45		135x110	105x80	12	55	199	350	
200GDH4BNBJ	200	45		135x110	105x80	12	55	239	400	
100DRH4BNB	100	36		105x85	80x60	9	39	128	200	
125DRH4BNB	125	36		105x85	80x60	9	44	152	250	



DRHBN FIXED									
GOLD BRACKET									
125GDH8BNBJ	125	55		135x110	105x80	12		166	310
150GDH8BNBJ	150	55		135x110	105x80	12		194	350
160GDH8BNB	160	45		135x110	105x80	12		199	350
200GDH8BNBJ	200	45		135x110	105x80	12		239	400
100DRH8BNB	100	36		105x85	80x60	9		128	200
125DRH8BNB	125	36		105x85	80x60	9		152	250



DRHBN BRAKED									
GOLD BRACKET									
125GDH4BNBJSWB	125	55		135x110	105x80	12	55	166	310
150GDH4BNBJSWB	150	55		135x110	105x80	12	55	194	350
160GDH4BNBSWB	160	45		135x110	105x80	12	55	199	350
200GDH4BNBJSWB	200	45		135x110	105x80	12	55	239	400
100DRH4BNBSWB	100	36		105x85	80x60	9	39	128	200
125DRH4BNBSWB	125	36		105x85	80x60	9	44	152	250



DRHBN BOLT HOLE									
100DRHBH12BNB	100	36				12.1	39	128	200
125DRHBH12BNB	125	36				12.1	44	152	250



DRHBN BOLT HOLE BRAKED									
100DRHBH12BNBSWB	100	36				12.1	39	128	200
125DRHBH12BNBSWB	125	36				12.1	44	152	250

EXPANDERS



DIRECTIONAL LOCK



Only Gold swivel castors.

INDUSTRIAL

SERIES: DRH/GDHEA

BRACKET: **HEAVY PRESSED STEEL**
 WHEEL: **ELASTIC RUBBER**
 ON **ALUMINIUM CENTRE**
 BEARING: **BALL BEARING**



MEDIUM / HEAVY



DRHEA SWIVEL

GOLD BRACKET

125GDH4EABJ	125	50		135x110	105x80	12	55	166	250
150GDH4EABJ	150	50		135x110	105x80	12	55	194	300
160GDH4EABJ	160	50		135x110	105x80	12	55	199	350
200GDH4EABJ	200	50		135x110	105x80	12	55	239	450
250GDH4EABJ	250	50		135x110	105x80	12	55	291	500
100DRH4EABJ	100	40		105x85	80x60	12	39	128	180
125DRH4EABJ	125	38		105x85	80x60	12	44	152	200



DRHEA FIXED

GOLD BRACKET

125GDH8EABJ	125	50		135x110	105x80	12	166	250
150GDH8EABJ	150	50		135x110	105x80	12	194	300
160GDH8EABJ	160	50		135x110	105x80	12	199	350
200GDH8EABJ	200	50		135x110	105x80	12	239	450
250GDH8EABJ	250	50		135x110	105x80	12	291	500
100DRH8EABJ	100	40		105x85	80x60		128	180
125DRH8EABJ	125	38		105x85	80x60		152	200



DRHEA BRAKED

GOLD BRACKET

125GDH4EABJSWB	125	50		135x110	105x80	12	55	166	250
150GDH4EABJSWB	150	50		135x110	105x80	12	55	194	300
160GDH4EABJSWB	160	50		135x110	105x80	12	55	199	350
200GDH4EABJSWB	200	50		135x110	105x80	12	55	239	450
250GDH4EABJSWB	250	50		135x110	105x80	12	55	291	500
100DRH4EABJSWB	100	40		105x85	80x60	12	39	128	180
125DRH4EABJSWB	125	38		105x85	80x60	12	44	152	200



DRHEA BOLT HOLE

100DRHBH12EABJ	100	40				12.1	39	128	180
125DRHBH12EABJ	125	38				12.1	44	152	200



DRHEA BOLT HOLE BRAKED

100DRHBH12EABJSWB	100	40				12.1	39	128	180
125DRHBH12EABJSWB	125	38				12.1	44	152	200

EXPANDERS



DIRECTIONAL LOCK



Only Gold swivel castors.

















INDUSTRIAL















SERIES: DRH/GDHRT

















BRACKET: **HEAVY PRESSED STEEL**
 WHEEL: **ELASTIC RUBBER**
 ON **CAST IRON CENTRE**
 BEARING: **BALL BEARING**















MEDIUM / HEAVY

	DRHRT										
	SWIVEL										
GOLD BRACKET	125GDH4RTBJ	125	50		135x110	105x80	12	55	166	275	
	150GDH4RTBJ	150	50		135x110	105x80	12	55	194	400	
	200GDH4RTBJ	200	50		135x110	105x80	12	55	239	600	
	250GDH4RTBJ	250	50		135x110	105x80	12	55	291	700	
	100DRH4RTBJ	100	38		105x85	80x60	9	39	128	180	
	125DRH4RTBJ	125	38		105x85	80x60	9	44	152	190	

	DRHRT									
	FIXED									
GOLD BRACKET	125GDH8RTBJ	125	50		135x110	105x80	12		166	275
	150GDH8RTBJ	150	50		135x110	105x80	12		194	400
	200GDH8RTBJ	200	50		135x110	105x80	12		239	600
	250GDH8RTBJ	250	50		135x110	105x80	12		291	700
	100DRH8RTBJ	100	38		105x85	80x60	9		128	180
	125DRH8RTBJ	125	38		105x85	80x60	9		152	190

	DRHRT										
	BRAKED										
GOLD BRACKET	125GDH4RTBJSWB	125	50		135x110	105x80	12	55	166	275	
	150GDH4RTBJSWB	150	50		135x110	105x80	12	55	194	400	
	200GDH4RTBJSWB	200	50		135x110	105x80	12	55	239	600	
	250GDH4RTBJSWB	250	50		135x110	105x80	12	55	291	700	
	100DRH4RTBJSWB	100	38		105x85	80x60	9	39	128	180	
	125DRH4RTBJSWB	125	38		105x85	80x60	9	44	152	190	

	DRHRT										
	BOLT HOLE										
	100DRHBH12RTBJ	100	38				12.1	39	128	180	
	125DRHBH12RTBJ	125	38				12.1	44	152	190	

	DRHRT										
	BOLT HOLE BRAKED										
	100DRHBH12RTBJSWB	100	38				12.1	39	128	180	
	125DRHBH12RTBJSWB	125	38				12.1	44	152	190	

EXPANDERS



DIRECTIONAL LOCK



Only Gold swivel castors.

INDUSTRIAL

SERIES: DRH/GDHCI

BRACKET: **HEAVY PRESSED STEEL**
 WHEEL: **CAST IRON**
 BEARING: **BALL BEARING**



MEDIUM / HEAVY



DRHCI SWIVEL										
GOLD BRACKET 125GDH4CIBJ	125	40		135x110	105x80	12	55	166	650	
150GDH4CIBJ	150	45		135x110	105x80	12	55	194	800	
200GDH4CIBJ	200	45		135x110	105x80	12	55	239	800	
250GDH4CIBJ	250	50		135x110	105x80	12	55	291	800	
100DRH4CIBJ	100	35		105x85	80x60	9	39	128	300	
125DRH4CIBJ	125	35		105x85	80x60	9	44	152	350	



DRHCI FIXED									
GOLD BRACKET 125GDH8CIBJ	125	40		135x110	105x80	12		166	650
150GDH8CIBJ	150	45		135x110	105x80	12		194	800
200GDH8CIBJ	200	45		135x110	105x80	12		239	800
250GDH8CIBJ	250	50		135x110	105x80	12		291	800
100DRH8CIBJ	100	35		105x85	80x60	9		128	300
125DRH8CIBJ	125	35		105x85	80x60	9		152	350



DRHCI BRAKED									
GOLD BRACKET 125GDH4CIBJSWB	125	40		135x110	105x80	12	55	166	650
150GDH4CIBJSWB	150	45		135x110	105x80	12	55	194	800
200GDH4CIBJSWB	200	45		135x110	105x80	12	55	239	800
250GDH4CIBJSWB	250	50		135x110	105x80	12	55	291	800
100DRH4CIBJSWB	100	35		105x85	80x60	9	39	128	300
125DRH4CIBJSWB	125	35		105x85	80x60	9	44	152	350



DRHCI BOLT HOLE										
100DRHBH12CIBJ	100	35					12.1	39	128	300
125DRHBH12CIBJ	125	35					12.1	44	152	350



DRHCI BOLT HOLE BRAKED										
100DRHBH12CIBJSWB	100	35					12.1	39	128	300
125DRHBH12CIBJSWB	125	35					12.1	44	152	350

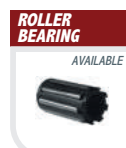

Only Gold swivel castors.

Only on 100 mm castors.

INDUSTRIAL

SERIES: DRH/GDHPN

BRACKET: **HEAVY PRESSED STEEL**
 WHEEL: **POLYURETHANE ON NYLON CENTRE**
 BEARING: **BALL BEARING**



MEDIUM / HEAVY



DRHPN SWIVEL										
GOLD BRACKET										
125GDH4PNBJ	125	50		135x110	105x80	12	55	166	340	
150GDH4PNBJ	150	50		135x110	105x80	12	55	194	430	
200GDH4PNBJ	200	50		135x110	105x80	12	55	239	500	
100DRH4PNBJ	100	38		105x85	80x60	9	39	128	250	
125DRH4PNBJ	125	38		105x85	80x60	9	44	152	280	



DRHPN FIXED									
GOLD BRACKET									
125GDH8PNBJ	125	50		135x110	105x80	12		166	340
150GDH8PNBJ	150	50		135x110	105x80	12		194	430
200GDH8PNBJ	200	50		135x110	105x80	12		239	500
100DRH8PNBJ	100	38		105x85	80x60	9		128	250
125DRH8PNBJ	125	38		105x85	80x60	9		152	280



DRHPN BRAKED									
GOLD BRACKET									
125GDH4PNBJSWB	125	50		135x110	105x80	12	55	166	340
150GDH4PNBJSWB	150	50		135x110	105x80	12	55	194	430
200GDH4PNBJSWB	200	50		135x110	105x80	12	55	239	500
100DRH4PNBJSWB	100	38		105x85	80x60	9	39	128	250
125DRH4PNBJSWB	125	38		105x85	80x60	9	44	152	280



DRHPN BOLT HOLE									
GOLD BRACKET									
100DRHBH12PNBJ	100	38				12.1	39	128	250
125DRHBH12PNBJ	125	38				12.1	44	152	280



DRHPN BOLT HOLE BRAKED									
GOLD BRACKET									
100DRHBH12PNBJSWB	100	38				12.1	39	128	250
125DRHBH12PNBJSWB	125	38				12.1	44	152	280

EXPANDERS



DIRECTIONAL LOCK



Only Gold swivel castors.

INDUSTRIAL

SERIES: GDHPX

BRACKET: **HEAVY PRESSED STEEL**
 WHEEL: **POLYURETHANE**
 ON **NYLON CENTRE**
 BEARING: **BALL BEARING**



MEDIUM / HEAVY



GDHPX SWIVEL

GOLO BRACKET	Ø	W	B	Icon 1	Icon 2	Icon 3	Icon 4	Icon 5	Icon 6	KG
125GDH4PXB	125	50	50	●●	135x110	105x80	12	55	166	380
150GDH4PXB	150	50	50	●●●	135x110	105x80	12	55	194	500
200GDH4PXB	200	50	50	●●●●	135x110	105x80	12	55	239	600



GDHPX FIXED

GOLO BRACKET	Ø	W	B	Icon 1	Icon 2	Icon 3	Icon 4	Icon 5	Icon 6	KG
125GDH8PXB	125	50	50	●●	135x110	105x80	12		166	380
150GDH8PXB	150	50	50	●●●	135x110	105x80	12		194	500
200GDH8PXB	200	50	50	●●●●	135x110	105x80	12		239	600



GDHPX BRAKED

GOLO BRACKET	Ø	W	B	Icon 1	Icon 2	Icon 3	Icon 4	Icon 5	Icon 6	KG
125GDH4PXBJSWB	125	50	50	●●	135x110	105x80	12	55	166	380
150GDH4PXBJSWB	150	50	50	●●●	135x110	105x80	12	55	194	500
200GDH4PXBJSWB	200	50	50	●●●●	135x110	105x80	12	55	239	600

DIRECTIONAL LOCK

AVAILABLE



Only Gold swivel castors.

INDUSTRIAL

SERIES: GDHOPU

BRACKET: **HEAVY PRESSED STEEL**
 WHEEL: **POLYURETHANE ON NYLON CENTRE**
 BEARING: **BALL BEARING**



MEDIUM / HEAVY



GDHOPU SWIVEL

GOLD BRACKET

125GDH40PUBJ	125	50		135x110	105x80	11	55	166	250
150GDH40PUBJ	150	50		135x110	105x80	11	55	194	300
200GDH40PUBJ	200	50		135x110	105x80	11	55	239	400



GDHOPU FIXED

GOLD BRACKET

125GDH80PUBJ	125	50		135x110	105x80	11	166	250
150GDH80PUBJ	150	50		135x110	105x80	11	194	300
200GDH80PUBJ	200	50		135x110	105x80	11	239	400



GDHOPU BRAKED

GOLD BRACKET

125GDH40PUBJSWB	125	50		135x110	105x80	11	55	166	250
150GDH40PUBJSWB	150	50		135x110	105x80	11	55	194	300
200GDH40PUBJSWB	200	50		135x110	105x80	11	55	239	400

DIRECTIONAL LOCK

AVAILABLE



Only Gold swivel castors.

INDUSTRIAL

SERIES: DRHEPN

BRACKET: **HEAVY PRESSED STEEL**
 WHEEL: **ELASTIC POLYURETHANE**
 ON **NYLON CENTRE**
 BEARING: **BALL BEARING**



MEDIUM / HEAVY



DRHEPN										
SWIVEL										
100DRH4EPNBJ	100	38			105x85	80x60	9	39	128	250
125DRH4EPNBJ	125	38			105x85	80x60	9	44	152	280



DRHEPN										
FIXED										
100DRH8EPNBJ	100	38			105x85	80x60	9		128	250
125DRH8EPNBJ	125	38			105x85	80x60	9		152	280



DRHEPN										
BRAKED										
100DRH4EPNBSWB	100	38			105x85	80x60	9	39	128	250
125DRH4EPNBSWB	125	38			105x85	80x60	9	44	152	280



DRHEPN										
BOLT HOLE										
100DRHBH12EPNBJ	100	38						12.1	39	128
125DRHBH12EPNBJ	125	38						12.1	44	152



DRHEPN										
BOLT HOLE BRAKED										
100DRHBH12EPNBSWB	100	38						12.1	39	128
125DRHBH12EPNBSWB	125	38						12.1	44	152

EXPANDERS

AVAILABLE

PAGE
148

INDUSTRIAL

SERIES: DRH/GDHPT

BRACKET: HEAVY PRESSED STEEL
WHEEL: POLYURETHANE
ON CAST IRON CENTRE
BEARING: BALL BEARING

MEDIUM / HEAVY



DRHPT										
SWIVEL										
GOLD BRACKET	125GDH4PTBJ	125	50		135x110	105x80	12	55	166	550
	150GDH4PTBJ	150	50		135x110	105x80	12	55	194	800
	200GDH4PTBJ	200	50		135x110	105x80	12	55	239	800
	250GDH4PTBJ	250	50		135x110	105x80	12	55	291	800
	100DRH4PTBJ	100	38		105x85	80x60	9	39	128	300
	125DRH4PTBJ	125	38		105x85	80x60	9	44	152	350



DRHPT										
FIXED										
GOLD BRACKET	125GDH8PTBJ	125	50		135x110	105x80	12		166	550
	150GDH8PTBJ	150	50		135x110	105x80	12		194	800
	200GDH8PTBJ	200	50		135x110	105x80	12		239	800
	250GDH8PTBJ	250	50		135x110	105x80	12		291	800
	100DRH8PTBJ	100	38		105x85	80x60	9		128	300
	125DRH8PTBJ	125	38		105x85	80x60	9		152	350



DRHPT										
BRAKED										
GOLD BRACKET	125GDH4PTBJSWB	125	50		135x110	105x80	12	55	166	550
	150GDH4PTBJSWB	150	50		135x110	105x80	12	55	194	800
	200GDH4PTBJSWB	200	50		135x110	105x80	12	55	239	800
	250GDH4PTBJSWB	250	50		135x110	105x80	12	55	291	800
	100DRH4PTBJSWB	100	38		105x85	80x60	9	39	128	300
	125DRH4PTBJSWB	125	38		105x85	80x60	9	44	152	350



DRHPT										
BOLT HOLE										
	100DRHBH12PTBJ	100	38				12.1	39	128	300
	125DRHBH12PTBJ	125	38				12.1	44	152	350



DRHPT										
BOLT HOLE BRAKED										
	100DRHBH12PTBJSWB	100	38				12.1	39	128	300
	125DRHBH12PTBJSWB	125	38				12.1	44	152	350

EXPANDERS



DIRECTIONAL LOCK



Only Gold swivel castors.

INDUSTRIAL

SERIES: GDHPTRP

BRACKET: **HEAVY PRESSED STEEL**
 WHEEL: **ROUND PROFILE POLYURETHANE**
 ON **CAST IRON CENTRE**
 BEARING: **BALL BEARING**



MEDIUM / HEAVY



GDHPTRP

SWIVEL

GOLD BRACKET

125GDH4PTBJRP	125	50		135x110	105x80	12	55	166	400
150GDH4PTBJRP	150	50		135x110	105x80	12	55	194	650
200GDH4PTBJRP	200	50		135x110	105x80	12	55	239	800



GDHPTRP

FIXED

GOLD BRACKET

125GDH8PTBJRP	125	50		135x110	105x80	12		166	400
150GDH8PTBJRP	150	50		135x110	105x80	12		194	650
200GDH8PTBJRP	200	50		135x110	105x80	12		239	800



GDHPTRP

BRAKED

GOLD BRACKET

125GDH4PTBJRPSWB	125	50		135x110	105x80	12	55	166	400
150GDH4PTBJRPSWB	150	50		135x110	105x80	12	55	194	650
200GDH4PTBJRPSWB	200	50		135x110	105x80	12	55	239	800

DIRECTIONAL LOCK

AVAILABLE



Only Gold swivel castors.



INDUSTRIAL

SERIES: DRH/GDHPTA

BRACKET: HEAVY PRESSED STEEL
 WHEEL: POLYURETHANE
 ON ALUMINIUM CENTRE
 BEARING: BALL BEARING

MEDIUM / HEAVY



DRHPTA										
SWIVEL										
GOLD BRACKET	125GDH4PTABJ	125	50		135x110	105x80	12	55	166	450
	150GDH4PTABJ	150	50		135x110	105x80	12	55	194	550
	160GDH4PTABJ	160	50		135x110	105x80	12	55	199	600
	200GDH4PTABJ	200	50		135x110	105x80	12	55	239	800
	100DRH4PTABJ	100	40		105x85	80x60	9	39	128	250
	125DRH4PTABJ	125	40		105x85	80x60	9	44	152	300



DRHPTA									
FIXED									
GOLD BRACKET	125GDH8PTABJ	125	50		135x110	105x80	12	166	450
	150GDH8PTABJ	150	50		135x110	105x80	12	194	550
	160GDH8PTABJ	160	50		135x110	105x80	12	199	600
	200GDH8PTABJ	200	50		135x110	105x80	12	239	800
	100DRH8PTABJ	100	40		105x85	80x60	9	128	250
	125DRH8PTABJ	125	40		105x85	80x60	9	152	300



DRHPTA										
BRAKED										
GOLD BRACKET	125GDH4PTABJSWB	125	50		135x110	105x80	12	55	166	450
	150GDH4PTABJSWB	150	50		135x110	105x80	12	55	194	550
	160GDH4PTABJSWB	160	50		135x110	105x80	12	55	199	600
	200GDH4PTABJSWB	200	50		135x110	105x80	12	55	239	800
	100DRH4PTABJSWB	100	40		105x85	80x60	9	39	128	250
	125DRH4PTABJSWB	125	40		105x85	80x60	9	44	152	300



DRHPTA										
BOLT HOLE										
	100DRHBH12PTABJ	100	40				12	39	128	250
	125DRHBH12PTABJ	125	40				12	44	152	300



DRHPTA										
BOLT HOLE BRAKED										
	100DRHBH12PTABJSWB	100	40				12	39	128	250
	125DRHBH12PTABJSWB	125	40				12	44	152	300

EXPANDERS

AVAILABLE

PAGE 148

DIRECTIONAL LOCK

AVAILABLE

Only Gold swivel castors.

INDUSTRIAL





SERIES: HSL











BRACKET: **POWDER COATED STEEL**
 WHEEL: **NYLON GLASS FIBRE & SOLID URETHANE**
 BEARING: **BALL BEARING**









LEVELLING CASTOR

 NYLON HSL SWIVEL																		
	50HSL4NY	65HSL4NY	50	65	24	29	70x70	90x90	58x58	70x70	6.5	9	82	104	200	400		

 NYLON HSL BOLT HOLE																		
	50HSLBH12NY	65HSLBH12NY	50	65	24	29					M12x1.75	M12x1.75	82	104	200	400		

 POLYURETHANE HSL SWIVEL																		
	50HSL4SU	65HSL4SU	50	65	24	29	70x70	90x90	58x58	70x70	6.5	9	82	104	200	400		

 POLYURETHANE HSL BOLT HOLE																		
	50HSLBH12SU	65HSLBH12SU	50	65	24	29					M12x1.75	M12x1.75	82	104	200	400		

MEDIUM / HEAVY

INDUSTRIAL

SERIES: GDNYLF / TL

BRACKET: **PRESSED STEEL**
 WHEEL: **NYLON**
 BEARING: **BALL BEARING**



MEDIUM / HEAVY

LEVELLING CASTOR



GDNYLF SWIVEL										
65GD4NYLF	65	43			120X120	98/93x 98/93	11	30	97	150
75GD4NYLF	75	45			120X120	98/93x 98/93	11	30	102	200

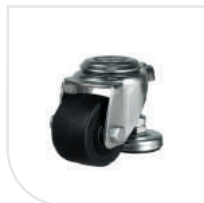

GDNYLF BOLT HOLE									
65GDBH13NYLF	65	43				13	30	94	150
75GDBH13NYLF	75	45				13	30	99	200



USE AND OPERATION

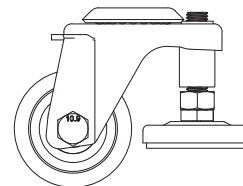

01
 When retracted, the foot pitches upward in the direction of motion and contacts the wheel on a point. This ensures ramp clearance, impact resistance and the foot will not be damaged by the rotating wheel.

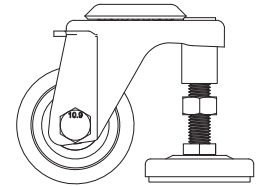

02
 The foot is adjusted downward until it touches the floor. Over a few turns, the weight will be fully transferred from the castor to the extended foot.

TRUCK LOCK

Our Truck locks are designed to enable a quick, free and easy change between locked and free movement modes. This is restored by the quick release pedal and moderate force. Our Truck Locks are of pressed steel with a zinc-plated finish.



TL					
TL4	125	151	120x120	85/100x 85/100	11
TL6	170	210	120x120	85/100x 85/100	11

INDUSTRIAL

SERIES: NB2LL / HGDNY

BRACKET: HEAVY PRESSED STEEL
 WHEEL: POLYURETHANE ON CAST IRON CENTRE,
 STEEL AND NYLON WHEELS
 BEARING: PLAIN



LOW LEVEL CASTORS

MEDIUM / HEAVY



POLYURETHANE ON CAST IRON CENTRE

NB2LL SWIVEL									
50NB2LLPT	50	14/14		95	51	6	12	64	160



STEEL

NB2LL SWIVEL									
50NB2LLST	50	14/14		95	51	6	12	64	270



NYLON

NB2LL SWIVEL									
50NB2LLNY	50	14/14		95	51	6	12	64	160

SCENE SHIFTERS



AVAILABLE

PAGE 148

HIGH LOAD LOW LEVEL

BRACKET: FABRICATED WHEEL: SOLID NYLON BEARING: BALL BEARING



HGDNY SWIVEL									
75HGD4NYBJ	75	46		110x85	80x60	9	24.5	105	400



HGDNY FIXED									
75HGD8NYBJ	75	46		110x85	80x60	9		105	400

INDUSTRIAL

SERIES: AGHWAPP

BRACKET: **FABRICATED**
 WHEEL: **NYLON**
 BEARING: **BALL BEARING**



MEDIUM / HEAVY



AGHWAPP

SWIVEL

100AGH4WAPPBJ	100	50		135x110	105x80	11	32	142	270
125AGH4WAPPBJ	125	50		135x110	105x80	11	43	165	300
150AGH4WAPPBJ	150	50		135x110	105x80	11	48	190	360
200AGH4WAPPBJ	200	50		135x110	105x80	11	60	240	400



AGHWAPP

FIXED

100AGH8WAPPBJ	100	50		135x110	105x80	11	142	270
125AGH8WAPPBJ	125	50		135x110	105x80	11	165	300
150AGH8WAPPBJ	150	50		135x110	105x80	11	190	360
200AGH8WAPPBJ	200	50		135x110	105x80	11	240	400



AGHWAPP

BRAKED

100AGH4WAPPBJSWB	100	50		135x110	105x80	11	32	142	270
125AGH4WAPPBJSWB	125	50		135x110	105x80	11	43	165	300
150AGH4WAPPBJSWB	150	50		135x110	105x80	11	48	190	360
200AGH4WAPPBJSWB	200	50		135x110	105x80	11	60	240	400

PLEASE NOTE: THIS IS A SWIVEL AND WHEEL BRAKE.
DIRECTIONAL LOCK AVAILABLE

INDUSTRIAL

SERIES: AGHOPU

BRACKET: **FABRICATED**
 WHEEL: **POLYURETHANE**
 ON **NYLON CENTRE**
 BEARING: **BALL BEARING**



MEDIUM / HEAVY



AGHOPU										
SWIVEL										
100AGH40PUBJ	100	50		135x110	105x80	11	32	142	220	
125AGH40PUBJ	125	50		135x110	105x80	11	43	165	280	
150AGH40PUBJ	150	50		135x110	105x80	11	48	190	350	
200AGH40PUBJ	200	50		135x110	105x80	11	60	240	430	



AGHOPU									
FIXED									
100AGH80PUBJ	100	50		135x110	105x80	11		142	220
125AGH80PUBJ	125	50		135x110	105x80	11		165	280
150AGH80PUBJ	150	50		135x110	105x80	11		190	350
200AGH80PUBJ	200	50		135x110	105x80	11		240	430



AGHOPU									
BRAKED									
100AGH40PUBJSWB	100	50		135x110	105x80	11	32	142	220
125AGH40PUBJSWB	125	50		135x110	105x80	11	43	165	280
150AGH40PUBJSWB	150	50		135x110	105x80	11	48	190	350
200AGH40PUBJSWB	200	50		135x110	105x80	11	60	240	430

PLEASE NOTE: THIS IS A SWIVEL AND WHEEL BRAKE.
DIRECTIONAL LOCK AVAILABLE

INDUSTRIAL

SERIES: AGHIRPU

BRACKET: **FABRICATED**
 WHEEL: **POLYURETHANE**
 ON **CAST IRON CENTRE**
 BEARING: **BALL BEARING**



MEDIUM / HEAVY



AGHIRPU									
SWIVEL									
100AGH4IRPU	100	50		135x110	105x80	11	32	142	260
125AGH4IRPU	125	50		135x110	105x80	11	43	165	360
150AGH4IRPU	150	50		135x110	105x80	11	48	190	400
200AGH4IRPU	200	50		135x110	105x80	11	60	240	450



AGHIRPU									
FIXED									
100AGH8IRPU	100	50		135x110	105x80	11		142	260
125AGH8IRPU	125	50		135x110	105x80	11		165	360
150AGH8IRPU	150	50		135x110	105x80	11		190	400
200AGH8IRPU	200	50		135x110	105x80	11		240	450



AGHIRPU									
BRAKED									
100AGH4IRPUSWB	100	50		135x110	105x80	11	32	142	260
125AGH4IRPUSWB	125	50		135x110	105x80	11	43	165	360
150AGH4IRPUSWB	150	50		135x110	105x80	11	48	190	400
200AGH4IRPUSWB	200	50		135x110	105x80	11	60	240	450

PLEASE NOTE: THIS IS A SWIVEL AND WHEEL BRAKE.
DIRECTIONAL LOCK AVAILABLE

INDUSTRIAL

SERIES: LMHNY

BRACKET: **FABRICATED**
 WHEEL: **NYLON**
 BEARING: **BALL BEARING**



MEDIUM / HEAVY



LMHNY SWIVEL									
100LMH4NYBJ	100	40		135x110	105x80	11	33	140	450
125LMH4NYBJ	125	45		135x110	105x80	11	40	165	500
150LMH4NYBJ	150	45		135x110	105x80	11	45	190	500
200LMH4NYBJ	200	50		135x110	105x80	11	54	241	500



LMHNY FIXED								
100LMH8NYBJ	100	40		135x110	105x80	11	140	450
125LMH8NYBJ	125	45		135x110	105x80	11	165	500
150LMH8NYBJ	150	45		135x110	105x80	11	190	500
200LMH8NYBJ	200	50		135x110	105x80	11	241	500



LMHNY BRAKED									
100LMH4NYBJBK	100	40		135x110	105x80	11	33	140	450
125LMH4NYBJBK	125	45		135x110	105x80	11	40	165	500
150LMH4NYBJBK	150	45		135x110	105x80	11	45	190	500
200LMH4NYBJBK	200	50		135x110	105x80	11	54	241	500

PLEASE NOTE: THIS BRAKED CASTOR IS A WHEEL BRAKE ONLY.
DIRECTIONAL LOCK AVAILABLE

INDUSTRIAL

SERIES: LMHBN

BRACKET: **FABRICATED**
 WHEEL: **ELASTIC NON-MARKING**
RUBBER ON NYLON CENTRE
 BEARING: **BALL BEARING**



MEDIUM / HEAVY



LMHBN										
SWIVEL										
100LMH4BNBJ	100	36		135x110	105x80	11	33	140	280	
125LMH4BNBJ	125	34		135x110	105x80	11	40	165	310	
150LMH4BNBJ	150	45		135x110	105x80	11	45	190	350	
200LMH4BNBJ	200	50		135x110	105x80	11	54	241	425	



LMHBN									
FIXED									
100LMH8BNBJ	100	36		135x110	105x80	11		140	280
125LMH8BNBJ	125	34		135x110	105x80	11		165	310
150LMH8BNBJ	150	45		135x110	105x80	11		190	350
200LMH8BNBJ	200	50		135x110	105x80	11		241	425



LMHBN									
BRAKED									
100LMH4BNBJBK	100	36		135x110	105x80	11	33	140	280
125LMH4BNBJBK	125	34		135x110	105x80	11	40	165	310
150LMH4BNBJBK	150	45		135x110	105x80	11	45	190	350
200LMH4BNBJBK	200	50		135x110	105x80	11	54	241	425

PLEASE NOTE: THIS BRAKED CASTOR IS A WHEEL BRAKE ONLY.
DIRECTIONAL LOCK AVAILABLE

INDUSTRIAL

SERIES: LMHEA

BRACKET: **FABRICATED**
 WHEEL: **ELASTIC RUBBER**
 ON **ALUMINIUM CENTRE**
 BEARING: **BALL BEARING**



MEDIUM / HEAVY



LMHEA										
SWIVEL										
100LMH4EABJ	100	50		135x110	105x80	11	33	140	220	
125LMH4EABJ	125	50		135x110	105x80	11	40	165	250	
150LMH4EABJ	150	50		135x110	105x80	11	45	190	300	
160LMH4EABJ	160	50		135x110	105x80	11	45	195	350	
200LMH4EABJ	200	50		135x110	105x80	11	54	241	450	



LMHEA										
FIXED										
100LMH8EABJ	100	50		135x110	105x80	11		140	220	
125LMH8EABJ	125	50		135x110	105x80	11		165	250	
150LMH8EABJ	150	50		135x110	105x80	11		190	300	
160LMH8EABJ	160	50		135x110	105x80	11		195	350	
200LMH8EABJ	200	50		135x110	105x80	11		241	450	



LMHEA										
BRAKED										
100LMH4EABJK	100	50		135x110	105x80	11	33	140	220	
125LMH4EABJK	125	50		135x110	105x80	11	40	165	250	
150LMH4EABJK	150	50		135x110	105x80	11	45	190	300	
160LMH4EABJK	160	50		135x110	105x80	11	45	195	350	
200LMH4EABJK	200	50		135x110	105x80	11	54	241	450	

PLEASE NOTE: THIS BRAKED CASTOR IS A WHEEL BRAKE ONLY.
DIRECTIONAL LOCK AVAILABLE

INDUSTRIAL

SERIES: LMHRT

BRACKET: **FABRICATED**
 WHEEL: **ELASTIC RUBBER**
 ON **CAST IRON CENTRE**
 BEARING: **BALL BEARING**



MEDIUM / HEAVY



LMHRT SWIVEL									
100LMH4RTBJ	100	50		135x110	105x80	11	33	140	210
125LMH4RTBJ	125	50		135x110	105x80	11	40	165	275
150LMH4RTBJ	150	50		135x110	105x80	11	45	190	400
200LMH4RTBJ	200	50		135x110	105x80	11	54	241	500



LMHRT FIXED									
100LMH8RTBJ	100	50		135x110	105x80	11		140	210
125LMH8RTBJ	125	50		135x110	105x80	11		165	275
150LMH8RTBJ	150	50		135x110	105x80	11		190	400
200LMH8RTBJ	200	50		135x110	105x80	11		241	500



LMHRT BRAKED									
100LMH4RTBJBK	100	50		135x110	105x80	11	33	140	210
125LMH4RTBJBK	125	50		135x110	105x80	11	40	165	275
150LMH4RTBJBK	150	50		135x110	105x80	11	45	190	400
200LMH4RTBJBK	200	50		135x110	105x80	11	54	241	500

PLEASE NOTE: THIS BRAKED CASTOR IS A WHEEL BRAKE ONLY.
DIRECTIONAL LOCK AVAILABLE

INDUSTRIAL

SERIES: LMHCI

BRACKET: **FABRICATED**
 WHEEL: **CAST IRON**
 BEARING: **BALL BEARING**



MEDIUM / HEAVY



LMHCI SWIVEL										
100LMH4CIBJ	100	50		135x110	105x80	11	33	140	450	
125LMH4CIBJ	125	40		135x110	105x80	11	40	165	500	
150LMH4CIBJ	150	45		135x110	105x80	11	45	190	500	
200LMH4CIBJ	200	45		135x110	105x80	11	54	241	500	



LMHCI FIXED									
100LMH8CIBJ	100	50		135x110	105x80	11		140	450
125LMH8CIBJ	125	40		135x110	105x80	11		165	500
150LMH8CIBJ	150	45		135x110	105x80	11		190	500
200LMH8CIBJ	200	45		135x110	105x80	11		241	500



LMHCI BRAKED									
100LMH4CIBJBK	100	50		135x110	105x80	11	33	140	450
125LMH4CIBJBK	125	40		135x110	105x80	11	40	165	500
150LMH4CIBJBK	150	45		135x110	105x80	11	45	190	500
200LMH4CIBJBK	200	45		135x110	105x80	11	54	241	500

PLEASE NOTE: THIS BRAKED CASTOR IS A WHEEL BRAKE ONLY.
DIRECTIONAL LOCK AVAILABLE

INDUSTRIAL

SERIES: LMHWAN

BRACKET: **FABRICATED**
 WHEEL: **PHENOLIC 120°C**
 BEARING: **ROLLER**



MEDIUM / HEAVY



LMHWAN										
SWIVEL										
150LMH4WAN 120	150	50		135x110	105x80	11	45	190	400	
200LMH4WAN 120	200	50		135x110	105x80	11	54	241	500	



LMHWAN									
FIXED									
150LMH8WAN 120	150	50		135x110	105x80	11		190	400
200LMH8WAN 120	200	50		135x110	105x80	11		241	500



LMHWAN									
BRAKED									
150LMH4WANBK 120	150	50		135x110	105x80	11	45	190	400
200LMH4WANBK 120	200	50		135x110	105x80	11	54	241	500

PLEASE NOTE: THIS BRAKED CASTOR IS A WHEEL BRAKE ONLY.
DIRECTIONAL LOCK AVAILABLE

INDUSTRIAL

SERIES: LMHWAN300

BRACKET: **FABRICATED**
 WHEEL: **PHENOLIC 300°C**
 BEARING: **ROLLER**



MEDIUM / HEAVY



LMHWAN300 SWIVEL									
150LMH4WAN 300	150	50		135x110	105x80	11	45	190	400
200LMH4WAN 300	200	50		135x110	105x80	11	54	241	500



LMHWAN300 FIXED									
150LMH8WAN 300	150	50		135x110	105x80	11		190	400
200LMH8WAN 300	200	50		135x110	105x80	11		241	500



LMHWAN300 BRAKED									
150LMH4WANBK 300	150	50		135x110	105x80	11	45	190	400
200LMH4WANBK 300	200	50		135x110	105x80	11	54	241	500

PLEASE NOTE: THIS BRAKED CASTOR IS A WHEEL BRAKE ONLY.
DIRECTIONAL LOCK AVAILABLE

INDUSTRIAL

SERIES: LMHPN

BRACKET: **FABRICATED**
 WHEEL: **POLYURETHANE**
 ON **NYLON CENTRE**
 BEARING: **BALL BEARING**



MEDIUM / HEAVY



LMHPN										
SWIVEL										
100LMH4PNBJ	100	50		135x110	105x80	11	33	140	280	
125LMH4PNBJ	125	50		135x110	105x80	11	40	165	340	
150LMH4PNBJ	150	50		135x110	105x80	11	45	190	430	
200LMH4PNBJ	200	50		135x110	105x80	11	54	241	500	



LMHPN									
FIXED									
100LMH8PNBJ	100	50		135x110	105x80	11		140	280
125LMH8PNBJ	125	50		135x110	105x80	11		165	340
150LMH8PNBJ	150	50		135x110	105x80	11		190	430
200LMH8PNBJ	200	50		135x110	105x80	11		241	500



LMHPN									
BRAKED									
100LMH4PNBJBK	100	50		135x110	105x80	11	33	140	280
125LMH4PNBJBK	125	50		135x110	105x80	11	40	165	340
150LMH4PNBJBK	150	50		135x110	105x80	11	45	190	430
200LMH4PNBJBK	200	50		135x110	105x80	11	54	241	500

**PLEASE NOTE: THIS BRAKED CASTOR IS A WHEEL BRAKE ONLY.
 DIRECTIONAL LOCK AVAILABLE**

INDUSTRIAL

SERIES: LMHPX

BRACKET: **FABRICATED**
 WHEEL: **POLYURETHANE**
 ON **NYLON** CENTRE
 BEARING: **BALL BEARING**



LMHPX SWIVEL									
100LMH4PXB J	100	50		135x110	105x80	11	33	140	300
125LMH4PXB J	125	50		135x110	105x80	11	40	165	380
150LMH4PXB J	150	50		135x110	105x80	11	45	190	500
200LMH4PXB J	200	50		135x110	105x80	11	54	241	500



LMHPX FIXED									
100LMH8PXB J	100	50		135x110	105x80	11		140	300
125LMH8PXB J	125	50		135x110	105x80	11		165	380
150LMH8PXB J	150	50		135x110	105x80	11		190	500
200LMH8PXB J	200	50		135x110	105x80	11		241	500



LMHPX BRAKED									
100LMH4PXB JK	100	50		135x110	105x80	11	33	140	300
125LMH4PXB JK	125	50		135x110	105x80	11	40	165	380
150LMH4PXB JK	150	50		135x110	105x80	11	45	190	500
200LMH4PXB JK	200	50		135x110	105x80	11	54	241	500

PLEASE NOTE: THIS BRAKED CASTOR IS A WHEEL BRAKE ONLY.
DIRECTIONAL LOCK AVAILABLE

MEDIUM / HEAVY

INDUSTRIAL

SERIES: LMHOPU

BRACKET: **FABRICATED**
 WHEEL: **POLYURETHANE**
 ON **NYLON CENTRE**
 BEARING: **BALL BEARING**



MEDIUM / HEAVY



LMHOPU										
SWIVEL										
100LMH40PUBJ	100	50		135x110	105x80	11	33	140	200	
125LMH40PUBJ	125	50		135x110	105x80	11	40	165	250	
150LMH40PUBJ	150	50		135x110	105x80	11	45	190	300	
200LMH40PUBJ	200	50		135x110	105x80	11	54	241	400	



LMHOPU									
FIXED									
100LMH80PUBJ	100	50		135x110	105x80	11		140	200
125LMH80PUBJ	125	50		135x110	105x80	11		165	250
150LMH80PUBJ	150	50		135x110	105x80	11		190	300
200LMH80PUBJ	200	50		135x110	105x80	11		241	400



LMHOPU									
BRAKED									
100LMH40PUBJBK	100	50		135x110	105x80	11	33	140	200
125LMH40PUBJBK	125	50		135x110	105x80	11	40	165	250
150LMH40PUBJBK	150	50		135x110	105x80	11	45	190	300
200LMH40PUBJBK	200	50		135x110	105x80	11	54	241	400

PLEASE NOTE: THIS BRAKED CASTOR IS A WHEEL BRAKE ONLY.
DIRECTIONAL LOCK AVAILABLE

INDUSTRIAL

SERIES: LMHPT

BRACKET: **FABRICATED**
 WHEEL: **POLYURETHANE**
 ON **CAST IRON** CENTRE
 BEARING: **BALL BEARING**



LMHPT SWIVEL									
100LMH4PTBJ	100	50		135x110	105x80	11	33	140	450
125LMH4PTBJ	125	50		135x110	105x80	11	40	165	500
150LMH4PTBJ	150	50		135x110	105x80	11	45	190	500
200LMH4PTBJ	200	50		135x110	105x80	11	54	241	500



LMHPT FIXED									
100LMH8PTBJ	100	50		135x110	105x80	11		140	450
125LMH8PTBJ	125	50		135x110	105x80	11		165	500
150LMH8PTBJ	150	50		135x110	105x80	11		190	500
200LMH8PTBJ	200	50		135x110	105x80	11		241	500



LMHPT BRAKED									
100LMH4PTBJBK	100	50		135x110	105x80	11	33	140	450
125LMH4PTBJBK	125	50		135x110	105x80	11	40	165	500
150LMH4PTBJBK	150	50		135x110	105x80	11	45	190	500
200LMH4PTBJBK	200	50		135x110	105x80	11	54	241	500

PLEASE NOTE: THIS BRAKED CASTOR IS A WHEEL BRAKE ONLY.
DIRECTIONAL LOCK AVAILABLE

MEDIUM / HEAVY

INDUSTRIAL

SERIES: LMHPTRP

BRACKET: **FABRICATED**
 WHEEL: **ROUND PROFILE POLYURETHANE**
 ON **CAST IRON CENTRE**
 BEARING: **BALL BEARING**



MEDIUM / HEAVY



LMHPTRP

SWIVEL

100LMH4PTBJRP	100	50		135x110	105x80	11	33	143	350	350
125LMH4PTBJRP	125	50		135x110	105x80	11	40	165	400	400
150LMH4PTBJRP	150	50		135x110	105x80	11	45	190	500	500
200LMH4PTBJRP	200	50		135x110	105x80	11	54	241	500	500



LMHPTRP

FIXED

100LMH8PTBJRP	100	50		135x110	105x80	11		143	350
125LMH8PTBJRP	125	50		135x110	105x80	11		165	400
150LMH8PTBJRP	150	50		135x110	105x80	11		190	500
200LMH8PTBJRP	200	50		135x110	105x80	11		241	500



LMHPTRP

BRAKED

100LMH4PTBJRPBK	100	50		135x110	105x80	11	33	143	350
125LMH4PTBJRPBK	125	50		135x110	105x80	11	40	165	400
150LMH4PTBJRPBK	150	50		135x110	105x80	11	45	190	500
200LMH4PTBJRPBK	200	50		135x110	105x80	11	54	241	500

PLEASE NOTE: THIS BRAKED CASTOR IS A WHEEL BRAKE ONLY.
DIRECTIONAL LOCK AVAILABLE

INDUSTRIAL

SERIES: LMHPTA

BRACKET: **FABRICATED**
 WHEEL: **POLYURETHANE**
 ON **ALUMINIUM CENTRE**
 BEARING: **BALL BEARING**



MEDIUM / HEAVY



LMHPTA									
SWIVEL									
125LMH4PTABJ	125	50		135x110	105x80	11	40	165	450
150LMH4PTABJ	150	50		135x110	105x80	11	45	190	500
200LMH4PTABJ	200	50		135x110	105x80	11	54	241	500



LMHPTA									
FIXED									
125LMH8PTABJ	125	50		135x110	105x80	11		165	450
150LMH8PTABJ	150	50		135x110	105x80	11		190	500
200LMH8PTABJ	200	50		135x110	105x80	11		241	500



LMHPTA									
BRAKED									
125LMH4PTABJK	125	50		135x110	105x80	11	40	165	450
150LMH4PTABJK	150	50		135x110	105x80	11	45	190	500
200LMH4PTABJK	200	50		135x110	105x80	11	54	241	500

PLEASE NOTE: THIS BRAKED CASTOR IS A WHEEL BRAKE ONLY.
DIRECTIONAL LOCK AVAILABLE

INDUSTRIAL

SERIES: LMHEPA

BRACKET: **FABRICATED**
 WHEEL: **ELASTIC POLYURETHANE**
ON ALUMINIUM CENTRE
 BEARING: **BALL BEARING**

Elast
Prene



LMHEPA										
SWIVEL										
160LMH4EPABJ	160	50			135x110	105x80	11	45	195	500
200LMH4EPABJ	200	50			135x110	105x80	11	54	241	500



LMHEPA										
FIXED										
160LMH8EPABJ	160	50			135x110	105x80	11		195	500
200LMH8EPABJ	200	50			135x110	105x80	11		241	500



LMHEPA										
BRAKED										
160LMH4EPABJBK	160	50			135x110	105x80	11	45	195	500
200LMH4EPABJBK	200	50			135x110	105x80	11	54	241	500

PLEASE NOTE: THIS BRAKED CASTOR IS A WHEEL BRAKE ONLY.
DIRECTIONAL LOCK AVAILABLE



INDUSTRIAL

SERIES: LMHATM

BRACKET: **FABRICATED**
 WHEEL: **PNEUMATIC ON STEEL CENTRE**
 BEARING: **BALL BEARING**



LMHATM									
SWIVEL									
200LMH4ATM	200	56		136x110	105x80	13	53	240	136
260LMH4ATM	260	83		136x110	105x80	13	58	302	158
300LMH4ATM	300	83		136x110	105x80	13	80	387	204



LMHATM									
FIXED									
200LMH8ATM	200	56		136x110	105x80	13		240	136
260LMH8ATM	260	83		136x110	105x80	13		302	158
300LMH8ATM	300	83		136x110	105x80	13		387	204

MEDIUM / HEAVY

INDUSTRIAL

SERIES: LMHBNY

BRACKET: **FABRICATED**
 WHEEL: **NYLON**
 BEARING: **BALL BEARING**



MEDIUM / HEAVY



LMHBNY SWIVEL

100LMHB4NYBJ	100	40		135x110	105x80	11	33	143	450	
125LMHB4NYBJ	125	45		135x110	105x80	11	40	165	500	
150LMHB4NYBJ	150	45		135x110	105x80	11	45	190	500	
200LMHB4NYBJ	200	50		135x110	105x80	11	54	240	500	



LMHBNY FIXED

100LMHB8NYBJ	100	40		135x110	105x80	11		143	450
125LMHB8NYBJ	125	45		135x110	105x80	11		165	500
150LMHB8NYBJ	150	45		135x110	105x80	11		190	500
200LMHB8NYBJ	200	50		135x110	105x80	11		240	500



LMHBNY BRAKED

100LMHB4NYBJSWB	100	40		135x110	105x80	11	33	143	450
125LMHB4NYBJSWB	125	45		135x110	105x80	11	40	165	500
150LMHB4NYBJSWB	150	45		135x110	105x80	11	45	190	500
200LMHB4NYBJSWB	200	50		135x110	105x80	11	54	240	500

INDUSTRIAL

SERIES: LMHBBN

BRACKET: **FABRICATED**
 WHEEL: **ELASTIC NON-MARKING RUBBER**
 ON **NYLON CENTRE**
 BEARING: **BALL BEARING**



LMHBBN									
SWIVEL									
100LMHB4BNBJ	100	36		135x110	105x80	11	33	143	280
125LMHB4BNBJ	125	40		135x110	105x80	11	40	165	310
150LMHB4BNBJ	150	45		135x110	105x80	11	45	190	350
200LMHB4BNBJ	200	50		135x110	105x80	11	54	241	425



LMHBBN								
FIXED								
100LMHB8BNBJ	100	36		135x110	105x80	11	143	280
125LMHB8BNBJ	125	40		135x110	105x80	11	165	310
150LMHB8BNBJ	150	45		135x110	105x80	11	190	350
200LMHB8BNBJ	200	50		135x110	105x80	11	241	425



LMHBBN									
BRAKED									
100LMHB4BNBJSWB	100	36		135x110	105x80	11	33	143	280
125LMHB4BNBJSWB	125	40		135x110	105x80	11	40	165	310
150LMHB4BNBJSWB	150	45		135x110	105x80	11	45	190	350
200LMHB4BNBJSWB	200	50		135x110	105x80	11	54	241	425

MEDIUM / HEAVY

INDUSTRIAL

SERIES: LMHBEA

BRACKET: **FABRICATED**
 WHEEL: **ELASTIC RUBBER**
 ON **ALUMINIUM CENTRE**
 BEARING: **BALL BEARING**



MEDIUM / HEAVY



LMHBEA										
SWIVEL										
100LMHB4EABJ	100	50		135x110	105x80	11	33	143	220	
125LMHB4EABJ	125	50		135x110	105x80	11	40	165	250	
150LMHB4EABJ	150	50		135x110	105x80	11	45	190	300	
160LMHB4EABJ	160	50		135x110	105x80	11	45	195	350	
200LMHB4EABJ	200	50		135x110	105x80	11	54	240	450	



LMHBEA										
FIXED										
100LMHB8EABJ	100	50		135x110	105x80	11		143	220	
125LMHB8EABJ	125	50		135x110	105x80	11		165	250	
150LMHB8EABJ	150	50		135x110	105x80	11		190	300	
160LMHB8EABJ	160	50		135x110	105x80	11		195	350	
200LMHB8EABJ	200	50		135x110	105x80	11		240	450	



LMHBEA										
BRAKED										
100LMHB4EABJSWB	100	50		135x110	105x80	11	33	143	220	
125LMHB4EABJSWB	125	50		135x110	105x80	11	40	165	250	
150LMHB4EABJSWB	150	50		135x110	105x80	11	45	190	300	
200LMHB4EABJSWB	200	50		135x110	105x80	11	54	240	450	

INDUSTRIAL

SERIES: LMHBRT

BRACKET: **FABRICATED**
 WHEEL: **ELASTIC RUBBER**
 ON **CAST IRON CENTRE**
 BEARING: **BALL BEARING**



LMHBRT

SWIVEL

100LMHB4RTBJ	100	50		135x110	105x80	11	33	143	210
125LMHB4RTBJ	125	50		135x110	105x80	11	40	165	275
150LMHB4RTBJ	150	50		135x110	105x80	11	45	190	400
200LMHB4RTBJ	200	50		135x110	105x80	11	54	241	500



LMHBRT

FIXED

100LMHB8RTBJ	100	50		135x110	105x80	11		143	210
125LMHB8RTBJ	125	50		135x110	105x80	11		165	275
150LMHB8RTBJ	150	50		135x110	105x80	11		190	400
200LMHB8RTBJ	200	50		135x110	105x80	11		241	500



LMHBRT

BRAKED

100LMHB4RTBJSWB	100	50		135x110	105x80	11	33	143	210
125LMHB4RTBJSWB	125	50		135x110	105x80	11	40	165	275
150LMHB4RTBJSWB	150	50		135x110	105x80	11	45	190	400
200LMHB4RTBJSWB	200	50		135x110	105x80	11	54	241	500

MEDIUM / HEAVY

INDUSTRIAL

SERIES: LMHBCI

BRACKET: **FABRICATED**
 WHEEL: **CAST IRON**
 BEARING: **BALL BEARING**



MEDIUM / HEAVY



LMHBCI

SWIVEL

100LMHB4CIBJ	100	50		135x110	105x80	11	33	143	450	
125LMHB4CIBJ	125	40		135x110	105x80	11	40	165	500	
150LMHB4CIBJ	150	45		135x110	105x80	11	45	190	500	
200LMHB4CIBJ	200	45		135x110	105x80	11	54	240	500	



LMHBCI

FIXED

100LMHB8CIBJ	100	50		135x110	105x80	11		143	450
125LMHB8CIBJ	125	40		135x110	105x80	11		165	500
150LMHB8CIBJ	150	45		135x110	105x80	11		190	500
200LMHB8CIBJ	200	45		135x110	105x80	11		240	500



LMHBCI

BRAKED

100LMHB4CIBJSWB	100	50		135x110	105x80	11	33	143	450
125LMHB4CIBJSWB	125	40		135x110	105x80	11	40	165	500
150LMHB4CIBJSWB	150	45		135x110	105x80	11	45	190	500
200LMHB4CIBJSWB	200	45		135x110	105x80	11	54	240	500

INDUSTRIAL

SERIES: LMHBWAN

BRACKET: **FABRICATED**
 WHEEL: **PHENOLIC 120**
 BEARING: **BALL BEARING**



LMHBWAN									
SWIVEL									
150LMHB4WAN 120	150	50		135x110	105x80	11	45	190	400
200LMHB4WAN 120	200	50		135x110	105x80	11	54	240	500



LMHBWAN									
FIXED									
150LMHB8WAN 120	150	50		135x110	105x80	11		190	400
200LMHB8WAN 120	200	50		135x110	105x80	11		240	500



LMHBWAN									
BRAKED									
150LMHB4WANSWB 120	150	50		135x110	105x80	11	45	190	400
200LMHB4WANSWB 120	200	50		135x110	105x80	11	54	240	500

AVAILABLE WITH 220°C WHEEL

MEDIUM / HEAVY

INDUSTRIAL

SERIES: LMHBPN

BRACKET: **FABRICATED**
 WHEEL: **POLYURETHANE**
 ON **NYLON CENTRE**
 BEARING: **BALL BEARING**



MEDIUM / HEAVY



LMHBPN

SWIVEL

100LMHB4PNBJ	100	50		135x110	105x80	11	33	143	280	
125LMHB4PNBJ	125	50		135x110	105x80	11	40	165	340	
150LMHB4PNBJ	150	50		135x110	105x80	11	45	190	430	
200LMHB4PNBJ	200	50		135x110	105x80	11	54	240	500	



LMHBPN

FIXED

100LMHB8PNBJ	100	50		135x110	105x80	11		143	280
125LMHB8PNBJ	125	50		135x110	105x80	11		165	340
150LMHB8PNBJ	150	50		135x110	105x80	11		190	430
200LMHB8PNBJ	200	50		135x110	105x80	11		240	500



LMHBPN

BRAKED

100LMHB4PNBJSWB	100	50		135x110	105x80	11	33	143	280
125LMHB4PNBJSWB	125	50		135x110	105x80	11	40	165	340
150LMHB4PNBJSWB	150	50		135x110	105x80	11	45	190	430
200LMHB4PNBJSWB	200	50		135x110	105x80	11	54	240	500

INDUSTRIAL

SERIES: LMHBPX

BRACKET: **FABRICATED**
 WHEEL: **POLYURETHANE**
 ON **NYLON** CENTRE
 BEARING: **BALL BEARING**



LMHBPX										
SWIVEL										
100LMHB4PXBJ	100	50		135x110	105x80	11	33	143	300	
125LMHB4PXBJ	125	50		135x110	105x80	11	40	165	380	
150LMHB4PXBJ	150	50		135x110	105x80	11	45	190	500	
200LMHB4PXBJ	200	50		135x110	105x80	11	54	240	500	



LMHBPX									
FIXED									
100LMHB8PXBJ	100	50		135x110	105x80	11		143	300
125LMHB8PXBJ	125	50		135x110	105x80	11		165	380
150LMHB8PXBJ	150	50		135x110	105x80	11		190	500
200LMHB8PXBJ	200	50		135x110	105x80	11		240	500



LMHBPX									
BRAKED									
100LMHB4PXBSWB	100	50		135x110	105x80	11	33	143	300
125LMHB4PXBSWB	125	50		135x110	105x80	11	40	165	380
150LMHB4PXBSWB	150	50		135x110	105x80	11	45	190	500
200LMHB4PXBSWB	200	50		135x110	105x80	11	54	240	500

MEDIUM / HEAVY

INDUSTRIAL

SERIES: LMHBOPU

BRACKET: **FABRICATED**
 WHEEL: **POLYURETHANE**
 ON **NYLON CENTRE**
 BEARING: **BALL BEARING**



MEDIUM / HEAVY



LMHBOPU

SWIVEL

100LMHB40PUBJ	100	50		135x110	105x80	11	33	143	280	280
125LMHB40PUBJ	125	50		135x110	105x80	11	40	165	340	340
150LMHB40PUBJ	150	50		135x110	105x80	11	45	190	430	430
200LMHB40PUBJ	200	50		135x110	105x80	11	54	240	500	500



LMHBOPU

FIXED

100LMHB80PUBJ	100	50		135x110	105x80	11		143	280	280
125LMHB80PUBJ	125	50		135x110	105x80	11		165	340	340
150LMHB80PUBJ	150	50		135x110	105x80	11		190	430	430
200LMHB80PUBJ	200	50		135x110	105x80	11		240	500	500



LMHBOPU

BRAKED

100LMHB40PUBJSWB	100	50		135x110	105x80	11	33	143	280	280
125LMHB40PUBJSWB	125	50		135x110	105x80	11	40	165	340	340
150LMHB40PUBJSWB	150	50		135x110	105x80	11	45	190	430	430
200LMHB40PUBJSWB	200	50		135x110	105x80	11	54	240	500	500

INDUSTRIAL

SERIES: LMHBPT

BRACKET: **FABRICATED**
 WHEEL: **POLYURETHANE**
 ON **CAST IRON** CENTRE
 BEARING: **BALL BEARING**



LMHBPT										
SWIVEL										
100LMHB4PTBJ	100	50		135x110	105x80	11	33	143	450	
125LMHB4PTBJ	125	50		135x110	105x80	11	40	165	500	
150LMHB4PTBJ	150	50		135x110	105x80	11	45	190	500	
200LMHB4PTBJ	200	50		135x110	105x80	11	54	240	500	



LMHBPT									
FIXED									
100LMHB8PTBJ	100	50		135x110	105x80	11		143	450
125LMHB8PTBJ	125	50		135x110	105x80	11		165	500
150LMHB8PTBJ	150	50		135x110	105x80	11		190	500
200LMHB8PTBJ	200	50		135x110	105x80	11		240	500



LMHBPT									
BRAKED									
100LMHB4PTBJSWB	100	50		135x110	105x80	11	33	143	450
125LMHB4PTBJSWB	125	50		135x110	105x80	11	40	165	500
150LMHB4PTBJSWB	150	50		135x110	105x80	11	45	190	500
200LMHB4PTBJSWB	200	50		135x110	105x80	11	54	240	500

MEDIUM / HEAVY

INDUSTRIAL

SERIES: LMHBPTRP

BRACKET: **FABRICATED**
 WHEEL: **ROUND PROFILE**
 POLYURETHANE ON CAST IRON CENTRE
 BEARING: **BALL BEARING**



MEDIUM / HEAVY



LMHBPTRP

SWIVEL

100LMHB4PTRPBJ	100	50		135x110	105x80	11	33	143	350	350
125LMHB4PTRPBJ	125	50		135x110	105x80	11	40	165	400	400
150LMHB4PTRPBJ	150	50		135x110	105x80	11	45	190	500	500
200LMHB4PTRPBJ	200	50		135x110	105x80	11	54	241	500	500



LMHBPTRP

FIXED

100LMHB8PTRPBJ	100	50		135x110	105x80	11		143	350	350
125LMHB8PTRPBJ	125	50		135x110	105x80	11		165	400	400
150LMHB8PTRPBJ	150	50		135x110	105x80	11		190	500	500
200LMHB8PTRPBJ	200	50		135x110	105x80	11		241	500	500



LMHBPTRP

BRAKED

100LMHB4PTRPBJSWB	100	50		135x110	105x80	11	33	143	350	350
125LMHB4PTRPBJSWB	125	50		135x110	105x80	11	40	165	400	400
150LMHB4PTRPBJSWB	150	50		135x110	105x80	11	45	190	500	500
200LMHB4PTRPBJSWB	200	50		135x110	105x80	11	54	241	500	500

INDUSTRIAL

SERIES: LMHBPTA

BRACKET: **FABRICATED**
 WHEEL: **POLYURETHANE**
 ON **ALUMINIUM** CENTRE
 BEARING: **BALL BEARING**



MEDIUM / HEAVY



LMHBPTA										
SWIVEL										
125LMHB4PTABJ	125	50		135x110	105x80	11	40	165	500	
150LMHB4PTABJ	150	50		135x110	105x80	11	45	190	500	
200LMHB4PTABJ	200	50		135x110	105x80	11	54	240	500	



LMHBPTA									
FIXED									
125LMHB8PTABJ	125	50		135x110	105x80	11		165	500
150LMHB8PTABJ	150	50		135x110	105x80	11		190	500
200LMHB8PTABJ	200	50		135x110	105x80	11		240	500



LMHBPTA									
BRAKED									
125LMHB4PTABJSWB	125	50		135x110	105x80	11	40	165	500
150LMHB4PTABJSWB	150	50		135x110	105x80	11	45	190	500
200LMHB4PTABJSWB	200	50		135x110	105x80	11	54	240	500

INDUSTRIAL

SERIES: LMHBEP

BRACKET: **FABRICATED**
 WHEEL: **ELASTIC POLYURETHANE**
 ON **ALUMINIUM CENTRE**
 BEARING: **BALL BEARING**

Elast
Prene



MEDIUM / HEAVY



LMHBEP SWIVEL									
160LMHB4EPABJ	160	50		135x110	105x80	11	45	195	500
200LMHB4EPABJ	200	50		135x110	105x80	11	54	240	500



LMHBEP FIXED									
160LMHB8EPABJ	160	50		135x110	105x80	11		195	500
200LMHB8EPABJ	200	50		135x110	105x80	11		240	500



LMHBEP BRAKED									
200LMHB4EPABJSWB	200	50		135x110	105x80	11	54	240	500

INDUSTRIAL

SERIES: NGRNY

BRACKET: **FABRICATED**
 WHEEL: **NYLON**
 BEARING: **BALL BEARING**



NGRNY SWIVEL

125NGR4NYBJ	125	45		149x110	105x80	13	45	177	750
150NGR4NYBJ	150	45		149x110	105x80	13	49	202	1000
200NGR4NYBJ	200	50		149x110	105x80	13	54	252	1000
250NGR4NYBJ	250	60		149x110	105x80	13	70	303	1200



NGRNY FIXED

125NGR8NYBJ	125	45		149x110	105x80	13		177	750
150NGR8NYBJ	150	45		149x110	105x80	13		202	1000
200NGR8NYBJ	200	50		149x110	105x80	13		252	1000
250NGR8NYBJ	250	60		149x110	105x80	13		303	1200



NGRNY BRAKED

125NGR4NYBJSWB	125	45		149x110	105x80	13	45	177	750
150NGR4NYBJSWB	150	45		149x110	105x80	13	49	202	1000
200NGR4NYBJSWB	200	50		149x110	105x80	13	54	252	1000
250NGR4NYBJSWB	250	60		149x110	105x80	13	70	303	1200

DIRECTIONAL LOCK



DIRECTIONAL LOCK AVAILABLE

HEAVY

INDUSTRIAL

SERIES: NGRRT

BRACKET: **FABRICATED**
 WHEEL: **ELASTIC RUBBER**
 ON **CAST IRON CENTRE**
 BEARING: **BALL BEARING**



HEAVY



NGRRT										
SWIVEL										
125NGR4RTBJ	125	50		149x110	105x80	13	45	177	275	
150NGR4RTBJ	150	50		149x110	105x80	13	49	202	400	
200NGR4RTBJ	200	50		149x110	105x80	13	54	252	600	
250NGR4RTBJ	250	50		149x110	105x80	13	70	303	700	



NGRRT										
FIXED										
125NGR8RTBJ	125	50		149x110	105x80	13		177	275	
150NGR8RTBJ	150	50		149x110	105x80	13		202	400	
200NGR8RTBJ	200	50		149x110	105x80	13		252	600	
250NGR8RTBJ	250	50		149x110	105x80	13		303	700	



NGRRT										
BRAKED										
125NGR4RTBJSWB	125	50		149x110	105x80	13	45	177	275	
150NGR4RTBJSWB	150	50		149x110	105x80	13	49	202	400	
200NGR4RTBJSWB	200	50		149x110	105x80	13	54	252	600	
250NGR4RTBJSWB	250	50		149x110	105x80	13	70	303	700	

DIRECTIONAL LOCK



DIRECTIONAL LOCK AVAILABLE

INDUSTRIAL

SERIES: NGREA

BRACKET: **FABRICATED**
 WHEEL: **ELASTIC RUBBER**
 ON **ALUMINIUM CENTRE**
 BEARING: **BALL BEARING**



NGREA SWIVEL									
125NGR4EABJ	125	50		149x110	105x80	13	45	177	250
150NGR4EABJ	150	50		149x110	105x80	13	49	202	300
160NGR4EABJ	160	50		149x110	105x80	13	49	207	350
200NGR4EABJ	200	50		149x110	105x80	13	54	252	450
250NGR4EABJ	250	50		149x110	105x80	13	70	303	550



NGREA FIXED								
125NGR8EABJ	125	50		149x110	105x80	13	177	250
150NGR8EABJ	150	50		149x110	105x80	13	202	300
160NGR8EABJ	160	50		149x110	105x80	13	207	350
200NGR8EABJ	200	50		149x110	105x80	13	252	450
250NGR8EABJ	250	50		149x110	105x80	13	303	550



NGREA BRAKED									
125NGR4EABJSWB	125	50		149x110	105x80	13	45	177	250
150NGR4EABJSWB	150	50		149x110	105x80	13	49	202	300
160NGR4EABJSWB	160	50		149x110	105x80	13	49	207	350
200NGR4EABJSWB	200	50		149x110	105x80	13	54	252	450
250NGR4EABJSWB	250	50		149x110	105x80	13	70	303	550

DIRECTIONAL LOCK



DIRECTIONAL LOCK AVAILABLE

HEAVY

INDUSTRIAL

SERIES: NGRCI

BRACKET: **FABRICATED**
 WHEEL: **CAST IRON**
 BEARING: **BALL BEARING**



HEAVY



NGRCI SWIVEL

125NGR4CIBJ	125	40		149x110	105x80	13	45	177	650
150NGR4CIBJ	150	45		149x110	105x80	13	49	202	900
200NGR4CIBJ	200	45		149x110	105x80	13	54	252	1100
250NGR4CIBJ	250	50		149x110	105x80	13	70	303	1300



NGRCI FIXED

125NGR8CIBJ	125	40		149x110	105x80	13	177	650
150NGR8CIBJ	150	45		149x110	105x80	13	202	900
200NGR8CIBJ	200	45		149x110	105x80	13	252	1100
250NGR8CIBJ	250	50		149x110	105x80	13	303	1300



NGRCI BRAKED

125NGR4CIBJSWB	125	40		149x110	105x80	13	45	177	650
150NGR4CIBJSWB	150	45		149x110	105x80	13	49	202	900
200NGR4CIBJSWB	200	45		149x110	105x80	13	54	252	1100
250NGR4CIBJSWB	250	50		149x110	105x80	13	70	303	1300

DIRECTIONAL LOCK

AVAILABLE



DIRECTIONAL LOCK AVAILABLE

INDUSTRIAL

SERIES: NGRPN

BRACKET: **FABRICATED**
 WHEEL: **POLYURETHANE**
 ON **NYLON** CENTRE
 BEARING: **BALL BEARING**



NGRPN SWIVEL									
125NGR4PNBJ	125	50		149x110	105x80	13	45	177	340
150NGR4PNBJ	150	50		149x110	105x80	13	49	202	430
200NGR4PNBJ	200	50		149x110	105x80	13	54	252	500



NGRPN FIXED									
125NGR8PNBJ	125	50		149x110	105x80	13		177	340
150NGR8PNBJ	150	50		149x110	105x80	13		202	430
200NGR8PNBJ	200	50		149x110	105x80	13		252	500



NGRPN BRAKED									
125NGR4PNBJSWB	125	50		149x110	105x80	13	45	177	340
150NGR4PNBJSWB	150	50		149x110	105x80	13	49	202	430
200NGR4PNBJSWB	200	50		149x110	105x80	13	54	252	500

DIRECTIONAL LOCK



DIRECTIONAL LOCK AVAILABLE

HEAVY

INDUSTRIAL

SERIES: NGRPX

BRACKET: **FABRICATED**
 WHEEL: **POLYURETHANE**
 ON **NYLON CENTRE**
 BEARING: **BALL BEARING**



HEAVY



NGRPX										
SWIVEL										
125NGR4PXBJ	125	50		149x110	105x80	13	45	177	380	
150NGR4PXBJ	150	50		149x110	105x80	13	49	202	500	
200NGR4PXBJ	200	50		149x110	105x80	13	54	252	600	



NGRPX									
FIXED									
125NGR8PXBJ	125	50		149x110	105x80	13		177	380
150NGR8PXBJ	150	50		149x110	105x80	13		202	500
200NGR8PXBJ	200	50		149x110	105x80	13		252	600



NGRPX									
BRAKED									
125NGR4PXBJSWB	125	50		149x110	105x80	13	45	177	380
150NGR4PXBJSWB	150	50		149x110	105x80	13	49	202	500
200NGR4PXBJSWB	200	50		149x110	105x80	13	54	252	600















DIRECTIONAL LOCK AVAILABLE

INDUSTRIAL











SERIES: NGROPUBJ

BRACKET: **FABRICATED**
 WHEEL: **POLYURETHANE**
 ON **NYLON** CENTRE
 BEARING: **BALL BEARING**















NGROPUBJ									
SWIVEL									
125NGR40PUBJ	125	50		149x110	105x80	13	45	177	250
150NGR40PUBJ	150	50		149x110	105x80	13	49	202	300
200NGR40PUBJ	200	50		149x110	105x80	13	54	252	400



NGRFOPUBJ								
FIXED								
125NGR80PUBJ	125	50		149x110	105x80	13	177	250
150NGR80PUBJ	150	50		149x110	105x80	13	202	300
200NGR80PUBJ	200	50		149x110	105x80	13	252	400



NGRFOPUBJ									
BRAKED									
125NGR40PUBJSWB	125	50		149x110	105x80	13	45	177	250
150NGR40PUBJSWB	150	50		149x110	105x80	13	49	202	300
200NGR40PUBJSWB	200	50		149x110	105x80	13	54	252	400

DIRECTIONAL LOCK



DIRECTIONAL LOCK AVAILABLE

HEAVY

INDUSTRIAL

SERIES: NGRPT

BRACKET: **FABRICATED**
 WHEEL: **POLYURETHANE**
 ON **CAST IRON CENTRE**
 BEARING: **BALL BEARING**



HEAVY



NGRPT										
SWIVEL										
125NGR4PTBJ	125	50		149x110	105x80	13	45	177	550	
150NGR4PTBJ	150	50		149x110	105x80	13	49	202	800	
200NGR4PTBJ	200	50		149x110	105x80	13	54	252	1000	
250NGR4PTBJ	250	50		149x110	105x80	13	70	303	1300	



NGRPT									
FIXED									
125NGR8PTBJ	125	50		149x110	105x80	13		177	550
150NGR8PTBJ	150	50		149x110	105x80	13		202	800
200NGR8PTBJ	200	50		149x110	105x80	13		252	1000
250NGR8PTBJ	250	50		149x110	105x80	13		303	1300



NGRPT									
BRAKED									
125NGR4PTBJSWB	125	50		149x110	105x80	13	45	177	550
150NGR4PTBJSWB	150	50		149x110	105x80	13	49	202	800
200NGR4PTBJSWB	200	50		149x110	105x80	13	54	252	1000
250NGR4PTBJSWB	250	50		149x110	105x80	13	70	303	1300

DIRECTIONAL LOCK

DIRECTIONAL LOCK AVAILABLE

AVAILABLE



INDUSTRIAL

SERIES: NGRPTRP

BRACKET: **FABRICATED**
 WHEEL: **ROUND PROFILE POLYURETHANE**
 ON **CAST IRON CENTRE**
 BEARING: **BALL BEARING**



NGRPTRP									
SWIVEL									
125NGR4PTBJRP	125	50		149x110	105x80	13	45	177	400
150NGR4PTBJRP	150	50		149x110	105x80	13	49	202	650
200NGR4PTBJRP	200	50		149x110	105x80	13	54	252	800



NGRPTRP									
FIXED									
125NGR8PTBJRP	125	50		149x110	105x80	13		177	400
150NGR8PTBJRP	150	50		149x110	105x80	13		202	650
200NGR8PTBJRP	200	50		149x110	105x80	13		252	800



NGRPTRP									
BRAKED									
125NGR4PTBJRPSWB	125	50		149x110	105x80	13	45	177	400
150NGR4PTBJRPSWB	150	50		149x110	105x80	13	49	202	650
200NGR4PTBJRPSWB	200	50		149x110	105x80	13	54	252	800

DIRECTIONAL LOCK



DIRECTIONAL LOCK AVAILABLE

HEAVY

INDUSTRIAL

SERIES: NGRPTA

BRACKET: **FABRICATED**
 WHEEL: **POLYURETHANE**
 ON **ALUMINIUM CENTRE**
 BEARING: **BALL BEARING**



HEAVY



NGRPTA										
SWIVEL										
125NGR4PTABJ	125	50		149x110	105x80	13	45	177	450	
150NGR4PTABJ	150	50		149x110	105x80	13	49	202	550	
160NGR4PTABJ	160	50		149x110	105x80	13	54	207	600	
200NGR4PTABJ	200	50		149x110	105x80	13	54	252	800	



NGRPTA									
FIXED									
125NGR8PTABJ	125	50		149x110	105x80	13		177	450
150NGR8PTABJ	150	50		149x110	105x80	13		202	550
160NGR8PTABJ	160	50		149x110	105x80	13		207	600
200NGR8PTABJ	200	50		149x110	105x80	13		252	800



NGRPTA									
BRAKED									
125NGR4PTABJSWB	125	50		149x110	105x80	13	45	177	450
150NGR4PTABJSWB	150	50		149x110	105x80	13	49	202	550
160NGR4PTABJSWB	160	50		149x110	105x80	13	54	207	600
200NGR4PTABJSWB	200	50		149x110	105x80	13	54	252	800



DIRECTIONAL LOCK AVAILABLE

INDUSTRIAL

SERIES: NGREPA

BRACKET: **FABRICATED**
 WHEEL: **ELASTIC POLYURETHANE**
 ON ALUMINIUM CENTRE
 BEARING: **BALL BEARING**

Elast
Prene



NGREPA										
SWIVEL										
16ONGR4EPABJ	160	50		149x110	105x80	13	49	207	600	
20ONGR4EPABJ	200	50		149x110	105x80	13	54	252	800	



NGREPA										
FIXED										
16ONGR8EPABJ	160	50		149x110	105x80	13		207	600	
20ONGR8EPABJ	200	50		149x110	105x80	13		252	800	



NGREPA										
BRAKED										
16ONGR4EPABJSWB	160	50		149x110	105x80	13	49	207	600	
20ONGR4EPABJSWB	200	50		149x110	105x80	13	54	252	800	

DIRECTIONAL LOCK



DIRECTIONAL LOCK AVAILABLE

HEAVY

INDUSTRIAL

SERIES: DNGRNY

BRACKET: **FABRICATED**
 WHEEL: **NYLON**
 BEARING: **BALL BEARING**



DNGRNY

SWIVEL

150DNGR4NYBJ	150	45/45		149x110	105x80	13	49	202	1500
200DNGR4NYBJ	200	50/50		149x110	105x80	13	54	252	1500



DNGRNY

FIXED

150DNGR8NYBJ	150	45/45		175x150	105x80	13		202	1500
200DNGR8NYBJ	200	50/50		175x150	105x80	13		252	1500

HEAVY

INDUSTRIAL

SERIES: DNGRRT

BRACKET: **FABRICATED**
 WHEEL: **RUBBER ON CAST IRON CENTRE**
 BEARING: **BALL BEARING**



HEAVY / EXTRA HEAVY



DNGRRT

SWIVEL

150DNGR4RTBJ	150	50/50		149x110	105x80	13	49	202	800	
200DNGR4RTBJ	200	50/50		149x110	105x80	13	54	252	1200	



DNGRRT

FIXED

150DNGR8RTBJ	150	50/50		175x150	105x80	13		202	800	
200DNGR8RTBJ	200	50/50		175x150	105x80	13		252	1200	

INDUSTRIAL

SERIES: DNGRCI

BRACKET: **FABRICATED**
 WHEEL: **CAST IRON**
 BEARING: **BALL BEARING**



DNGRCI										
SWIVEL										
150DNGR4CIBJ	150	45/45		149x110	105x80	13	49	202		1500
200DNGR4CIBJ	200	45/45		149x110	105x80	13	54	252		1500



DNGRCI										
FIXED										
150DNGR8CIBJ	150	45/45		175x150	105x80	13		202		1500
200DNGR8CIBJ	200	45/45		175x150	105x80	13		252		1500

INDUSTRIAL

SERIES: DNGRPN

BRACKET: **FABRICATED**
 WHEEL: **POLYURETHANE**
 ON **NYLON** CENTRE
 BEARING: **BALL BEARING**



HEAVY / EXTRA HEAVY



DNGRPN										
SWIVEL										
150DNGR4PNBJ	150	50/50		149x110	105x80	13	49	202	860	
200DNGR4PNBJ	200	50/50		149x110	105x80	13	54	252	1000	



DNGRPN									
FIXED									
150DNGR8PNBJ	150	50/50		175x150	105x80	13		202	860
200DNGR8PNBJ	200	50/50		175x150	105x80	13		252	1000

INDUSTRIAL

SERIES: DNGRPX

BRACKET: **FABRICATED**
 WHEEL: **POLYURETHANE**
 ON **NYLON CENTRE**
 BEARING: **BALL BEARING**



DNGRPX

SWIVEL

150DNGR4PXB	150	50/50		149x110	105x80	13	49	202	1000	
200DNGR4PXB	200	50/50		149x110	105x80	13	54	252	1200	



DNGRPX

FIXED

150DNGR8PXB	150	50/50		175x150	105x80	13		202	1000	
200DNGR8PXB	200	50/50		175x150	105x80	13		252	1200	

INDUSTRIAL

SERIES: DNGRPT

BRACKET: **FABRICATED**
 WHEEL: **POLYURETHANE**
 ON **CAST IRON** CENTRE
 BEARING: **BALL BEARING**



DNGRPT

SWIVEL

150DNGR4PTBJ	150	50/50		149x110	105x80	13	49	202	1500
200DNGR4PTBJ	200	50/50		149x110	105x80	13	54	252	1500



DNGRPT

FIXED

150DNGR8PTBJ	150	50/50		175x150	105x80	13		202		1500
200DNGR8PTBJ	200	50/50		175x150	105x80	13		252		1500

HEAVY / EXTRA HEAVY

INDUSTRIAL

SERIES: DNGRPTRP

BRACKET: FABRICATED
 WHEEL: ROUND PROFILE POLYURETHANE
 ON CAST IRON CENTRE
 BEARING: BALL BEARING



HEAVY / EXTRA HEAVY



DNGRPTRP

SWIVEL

150DNGR4PTBJRP	150	50/50		149x110	105x80	13	49	202	1300	
200DNGR4PTBJRP	200	50/50		149x110	105x80	13	54	252	1500	



DNGRPTRP

FIXED

150DNGR8PTBJRP	150	50/50		175x150	105x80	13		202	1300	
200DNGR8PTBJRP	200	50/50		175x150	105x80	13		252	1500	

INDUSTRIAL









SERIES: DNGRPTA

BRACKET: **FABRICATED**
 WHEEL: **POLYURETHANE**
 ON **ALUMINIUM CENTRE**
 BEARING: **BALL BEARING**



DNGRPTA











SWIVEL

									
150DNGR4PTABJ	150	50/50		149x110	105x80	13	49	202	1100
200DNGR4PTABJ	200	50/50		149x110	105x80	13	54	252	1500



DNGRPTA

FIXED

									
150DNGR8PTABJ	150	50/50		175x150	105x80	13		202	1100
200DNGR8PTABJ	200	50/50		175x150	105x80	13		252	1500

HEAVY / EXTRA HEAVY

INDUSTRIAL

SERIES: DNGREPA

BRACKET: **FABRICATED**
 WHEEL: **ELASTIC POLYURETHANE ON ALUMINIUM CENTRE**
 BEARING: **BALL BEARING**

Elast
Prene



DNGREPA										
SWIVEL										
160DNGR4EPABJ	160	50/50		149x110	105x80	13	49	207	1200	
200DNGR4EPABJ	200	50/50		149x110	105x80	13	54	252	1500	



DNGREPA										
FIXED										
160DNGR8EPABJ	160	50/50		175x150	105x80	13		207	1200	
200DNGR8EPABJ	200	50/50		175x150	105x80	13		252	1500	

INDUSTRIAL

SERIES: NXHCNY

BRACKET: **FABRICATED**
 WHEEL: **CAST NYLON**
 BEARING: **BALL BEARING**



EXTRA HEAVY



NXHCNY										
SWIVEL										
200NXH4CNYBJ	200	80			175x140	140x105	14	63	264	2500
250NXH4CNYBJ	250	80			175x140	140x105	14	68	315	2500
300NXH4CNYBJ	300	80			175x140	140x105	14	80	365	2500



NXHCNY										
FIXED										
200NXH8CNYBJ	200	80			175x140	140x105	14		264	2500
250NXH8CNYBJ	250	80			175x140	140x105	14		315	2500
300NXH8CNYBJ	300	80			175x140	140x105	14		365	2500



NXHCNY										
BRAKED										
200NXH4CNYBJSWB	200	80			175x140	140x105	14	63	264	2500
250NXH4CNYBJSWB	250	80			175x140	140x105	14	68	315	2500
300NXH4CNYBJSWB	300	80			175x140	140x105	14	80	365	2500

PLEASE NOTE: THIS BRAKED CASTOR IS A WHEEL BRAKE ONLY.
DIRECTIONAL LOCK AVAILABLE

INDUSTRIAL

SERIES: NXHDI

BRACKET: **FABRICATED**
 WHEEL: **DUCTILE IRON**
 BEARING: **BALL BEARING**



EXTRA HEAVY



NXHDI										
SWIVEL										
200NXH4DIBJ	200	75		175x140	140x105	14	63	264	2500	
250NXH4DIBJ	250	75		175x140	140x105	14	68	315	2500	
300NXH4DIBJ	300	75		175x140	140x105	14	80	365	2500	



NXHDI									
FIXED									
200NXH8DIBJ	200	75		175x140	140x105	14		264	2500
250NXH8DIBJ	250	75		175x140	140x105	14		315	2500
300NXH8DIBJ	300	75		175x140	140x105	14		365	2500



NXHDI									
BRAKED									
200NXH4DIBJSWB	200	75		175x140	140x105	14	63	264	2500
250NXH4DIBJSWB	250	75		175x140	140x105	14	68	315	2500
300NXH4DIBJSWB	300	75		175x140	140x105	14	80	365	2500

PLEASE NOTE: THIS BRAKED CASTOR IS A WHEEL BRAKE ONLY.
DIRECTIONAL LOCK AVAILABLE

INDUSTRIAL

SERIES: NXHPT

BRACKET: **FABRICATED**
 WHEEL: **POLYURETHANE**
 ON **CAST IRON** CENTRE
 BEARING: **BALL BEARING**



EXTRA HEAVY



NXHPT SWIVEL									
	200NXH4PTBJ	200	75		175x140	140x105	14	63	264
250NXH4PTBJ	250	75		175x140	140x105	14	68	315	1800
300NXH4PTBJ	300	75		175x140	140x105	14	80	365	2200



NXHPT FIXED									
	200NXH8PTBJ	200	75		175x140	140x105	14		264
250NXH8PTBJ	250	75		175x140	140x105	14		315	1800
300NXH8PTBJ	300	75		175x140	140x105	14		365	2200



NXHPT BRAKED									
	200NXH4PTBJSWB	200	75		175x140	140x105	14	63	264
250NXH4PTBJSWB	250	75		175x140	140x105	14	68	315	1800
300NXH4PTBJSWB	300	75		175x140	140x105	14	80	365	2200

PLEASE NOTE: THIS BRAKED CASTOR IS A WHEEL BRAKE ONLY.
DIRECTIONAL LOCK AVAILABLE

INDUSTRIAL

SERIES: DNXHNY

BRACKET: **FABRICATED**
 WHEEL: **NYLON**
 BEARING: **BALL BEARING**



EXTRA HEAVY



DNXHNY

SWIVEL

150DNXH4NYBJ	150	45/45		175x140	140x105	14	63	214	2000	
200DNXH4NYBJ	200	50/50		175x140	140x105	14	68	264	2000	
250DNXH4NYBJ	250	60/60		175x140	140x105	14	80	315	2500	



DNXHNY

FIXED

150DNXH8NYBJ	150	45/45		175x140	140x105	14		214	2000	
200DNXH8NYBJ	200	50/50		175x140	140x105	14		264	2000	
250DNXH8NYBJ	250	60/60		175x140	140x105	14		315	2500	

DIRECTIONAL LOCK AVAILABLE

INDUSTRIAL

SERIES: DNXHCI

BRACKET: **FABRICATED**
 WHEEL: **CAST IRON**
 BEARING: **BALL BEARING**



DNXHCI SWIVEL

150DNXH4CIBJ	150	45/45		175x140	140x105	14	63	214	1800
200DNXH4CIBJ	200	45/45		175x140	140x105	14	68	264	2200
250DNXH4CIBJ	250	50/50		175x140	140x105	14	80	315	2500



DNXHCI FIXED

150DNXH8CIBJ	150	45/45		175x140	140x105	14		214	1800	
200DNXH8CIBJ	200	45/45		175x140	140x105	14		264	2200	
250DNXH8CIBJ	250	50/50		175x140	140x105	14		315	2500	

DIRECTIONAL LOCK AVAILABLE

EXTRA HEAVY

INDUSTRIAL

SERIES: DNXHPT

BRACKET: **FABRICATED**
 WHEEL: **POLYURETHANE**
 ON **CAST IRON CENTRE**
 BEARING: **BALL BEARING**



EXTRA HEAVY



DNXHPT										
SWIVEL										
150DNXH4PTBJ	150	50/50		175x140	140x105	14	63	214	1600	
200DNXH4PTBJ	200	50/50		175x140	140x105	14	68	264	2000	
250DNXH4PTBJ	250	50/50		175x140	140x105	14	80	315	2500	



DNXHPT										
FIXED										
150DNXH8PTBJ	150	50/50		175x140	140x105	14		214	1600	
200DNXH8PTBJ	200	50/50		175x140	140x105	14		264	2000	
250DNXH8PTBJ	250	50/50		175x140	140x105	14		315	2500	

DIRECTIONAL LOCK AVAILABLE

INDUSTRIAL

SERIES: DWDHPT

BRACKET: **FABRICATED**
 WHEEL: **POLYURETHANE ON**
CAST IRON CENTRE
 BEARING: **BALL BEARING**

LOAD TEST CONDITION: 1.4km/h, 3HRS
LINEAR TRACK DYNAMIC TEST MACHINE



DWHPT SWIVEL	300	75	184x133	SLOTTED		SLOTTED		110	393	KG
				156/133x 86/105	15x14	156/152x 105/114	15x14			
300DWH4PTBJ	300	75	184x133	156/133x 86/105	15x14	156/152x 105/114	15x14	110	393	2500
400DWH4PTBJ	400	100	191x159	156/152x 105/114	15x14			111	483	4500



DWHPT FIXED	300	75	184x133	SLOTTED		SLOTTED		393	KG
				156/133x 86/105	15x14	156/152x 105/114	15x14		
300DWH8PTBJ	300	75	184x133	156/133x 86/105	15x14			393	2500
400DWH8PTBJ	400	100	191x159	156/152x 105/114	15x14			483	4500



DWHPT BRAKED	300	75	184x133	SLOTTED		SLOTTED		110	393	KG
				156/133x 86/105	15x14	156/152x 105/114	15x14			
300DWH4PTBJFB	300	75	184x133	156/133x 86/105	15x14	156/152x 105/114	15x14	110	393	2500
400DWH4PTBJFB	400	100	191x159	156/152x 105/114	15x14			111	483	4500



DWHPT DIRECTIONAL LOCK	300	75	184x133	SLOTTED		SLOTTED		110	393	KG
				156/133x 86/105	15x14	156/152x 105/114	15x14			
300DWH4PTBJDL	300	75	184x133	156/133x 86/105	15x14	156/152x 105/114	15x14	110	393	2500
400DWH4PTBJDL	400	100	191x159	156/152x 105/114	15x14			111	483	4500



DWHPT DIRECTIONAL LOCK & BRAKE	300	75	184x133	SLOTTED		SLOTTED		110	393	KG
				156/133x 86/105	15x14	156/152x 105/114	15x14			
300DWH4PTBJFBDL	300	75	184x133	156/133x 86/105	15x14	156/152x 105/114	15x14	110	393	2500
400DWH4PTBJFBDL	400	100	191x159	156/152x 105/114	15x14			111	483	4500

ULTRA HEAVY

INDUSTRIAL

SERIES: DWDHPT

BRACKET: **FABRICATED**
 WHEEL: **POLYURETHANE ON**
CAST IRON CENTRE
 BEARING: **BALL BEARING**

LOAD TEST CONDITION: 1.4km/h, 3HRS
LINEAR TRACK DYNAMIC TEST MACHINE



ULTRA HEAVY



DWDHPT SWIVEL	Ø	WxH	Bearing	Bracket	SLOTTED		Lock	Weight (KG)	
					WxH	Lock			
200DWDH4PTBJ	200	75/75	●●	191x159	152/156x105/114	14x19	59	292	3600
250DWDH4PTBJ	250	75/75	●●	191x159	152/156x105/114	14x19	77	352	4500



DWDHPT FIXED	Ø	WxH	Bearing	Bracket	SLOTTED		Lock	Weight (KG)	
					WxH	Lock			
200DWDH8PTBJ	200	75/75	●●	191x288	152/156x105/114	14x19		292	3600
250DWDH8PTBJ	250	75/75	●●	191x288	152/156x105/114	14x19		352	4500

DIRECTIONAL LOCK AVAILABLE



INDUSTRIAL

SERIES: DWDUHPT

BRACKET: **FABRICATED**
 WHEEL: **POLYURETHANE**
 ON **CAST IRON** CENTRE
 BEARING: **TAPER BEARING**

LOAD TEST CONDITION: 1.4km/h, 3HRS
LINEAR TRACK DYNAMIC TEST MACHINE



DWDUHPT

SWIVEL

300DWDUH4PTT	300	75/75			320x320	SLOTTED 					7000
400DWDUH4PTT	400	100/100			320x320						10000



DWDUHPT

FIXED

300DWDUH8PTT	300	75/75			320x320	SLOTTED 					7000
400DWDUH8PTT	400	100/100			320x320						10000

ULTRA HEAVY

WHEELS



WHEELS



WTPR

Grey Rubber on Plastic Centre

50WTPRDL	50	20		6/8	24/21	40
50WTPRGD	50	17		8	21	40
75WTPRDL	75	23		8	30	50
75WTPRGD	75	24		8	25	50
80WTPR	80	32		12	40	60
100WTPRDL	100	27		12	31	75
100WTPRLW	100	32		12	35	90
100WTPRGD	100	24		12	25	80
100WTPR	100	32		12	40	80
125WTPRDL	125	27		12	31	90
125WTPRLW	125	32		12	35	120
125WTPR	125	32		12	45	100
150WTPRLW	150	32		12	35	130



*Anti Static available



WTPRBJG

100WTPRBJG	100	32		8	35	90
125WTPRBJG	125	32		8	35	110
150WTPRBJG	150	32		8	35	120



WTPRBJG BOX

100WTPRBJ BOX	100	30		8	36	70
125WTPRBJ BOX	125	32		8	36	90
160WTPRBJ BOX	160	38		12	59	140
200WTPRBJ BOX	200	42		12	59	200

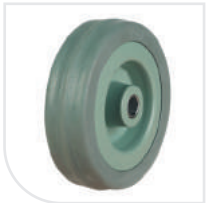

WGR

Grey Rubber on Plastic Centre

50WGR	50	17		8	22	40
75WGR	75	21		10	24	50
100WGR	100	27		12	31	80
125WGR	125	27		12	31	100



WPSB

Rubber Tyre on Plastic Centre

80WPSB	80	30		12	40	65
100WPSB	100	32		12	40	80
125WPSB	125	37		12	45	100
160WPSB	160	40		20	60	175
200WPSB	200	50		20	60	205
250WLP SRBM	250	60		20/25/25.4	60	250

WHEELS



WEABJ Elastic Rubber on Aluminium Centre

80WEABJ	80	36		15	40	100
100WEABJ	100	40		15	40	180
100WEA50BJ	100	50		17	56	220
125WEABJ	125	38		15	41	200
125WEA50BJ	125	50		20/25	56	250
150WEA50BJ	150	50		20/25	56	300
160WEABJ	160	50		20/25	60	350
200WEABJ	200	50		20/25	60	450
250WEABJ	250	50		20/25	60	550



WBSB Rubber on Steel Disk Centre

80WBSB	80	30		12	40	65
100WBSB	100	32		12	40	80
125WBSB	125	37		12/15	45	100
160WBSB	160	40		20	60	175
200WBSB	200	50		20	60	205



WGRB Grey Rubber on Plastic Centre

80WGRB	80	30		12	40	65
100WGRB	100	32		12	40	80
125WGRB	125	37		15	45	100
160WGRB	160	40		20	60	175
200WGRB	200	50		20	60	205

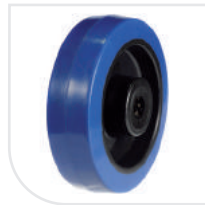

WBNB Blue Synthetic Rubber

80WBNB	80	34		12	40	150
100WBNB	100	34		12	40	180
100WBNB	100	36		12	44	200
125WBNB	125	36		12	46	250
160WBNB	160	45		20	60	350
200WBNB	200	45		20	60	400



WBNBJ Blue Synthetic Rubber

100WBNBJ	100	50		12	60	150
125WBNBJ	125	50		12	60	210
150WBNBJ	150	50		12	60	300
200WBNBJ	200	45		20	60	400



WRTBJ Rubber on Cast Iron Centre

100WRT36BJ	100	36		20	43	180
100WRTBJ	100	50		20/25	60	210
125WRT38BJ	125	38		20	45	190
125WRTBJ	125	50		20/25	60	275
150WRTBJ	150	50		20/25	60	400
200WRTBJ	200	50		20/25	60	600
250WRTBJ	250	50		20/25	60	700
300WRTBJ	300	50		20/25	60	800

WHEELS



WHEELS



WPNO Poly Nylon						
80WPNO	80	30		12	40	100
100WPNO	100	30		12	40	150
125WPNO	125	35		15	44	200
150WPNO	150	50		15	45	280
160WPNO	160	38		20	58	250
200WPNO	200	50		20	60	500



WPNOB Poly Nylon						
80WPNOB	80	30		12	40	100
100WPNOB	100	30		12	40	150
125WPNOB	125	35		15	44	200
150WPNOB	150	40		20	58	350
160WPNOB/SS	160	50		20	58	350
200WPNOB	200	50		20	60	500



WPNR Poly Nylon						
100WPNRB	100	34		12	41	200
125WPNRB	125	40		12	44	260



WPNBJM Poly Nylon						
100WPNBJ38	100	38		15	41	250
100WPNBJ	100	50		17	56	280
125WPNBJ38	125	38		15	41	280
125WPNBJ	125	50		17	56	340
150WPNBJ	150	50		12/15	62/56	430
150WPNOBJ	150	45		20/25	58	450
200WPNBJ	200	50		12/15	62/56	500
200WPNOBJ	200	50		20/25	58	600



WPXBJ Resilient Poly Nylon						
100WPXBJ	100	50		12	60	300
125WPXBJ	125	50		12	60	380
150WPXBJ	150	50		12	60	500
200WPXBJ	200	50		12	60	600



WOPUBJ Resilient Poly Nylon						
100WOPUBJ	100	50		17	60	200
125WOPUBJ	125	50		17	60	250
150WOPUBJ	150	50		17	60	300
200WOPUBJ	200	50		17	60	400

WHEELS

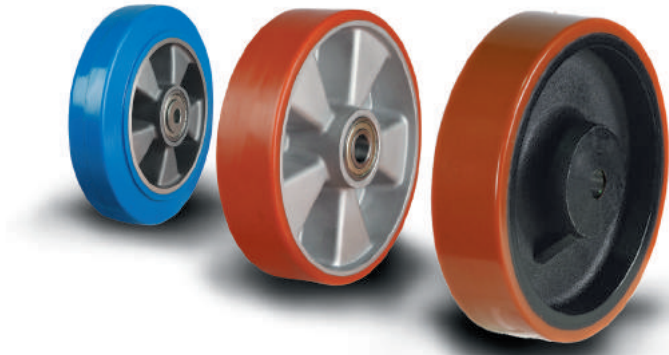

WEPN 80 SHORE A

Elastic Poly Nylon

80WEPN	80	32		12	40	100
100WEPN	100	32		12	40	150
125WEPN	125	32		12	40	175
150WEPN	150	42		20	60	200
200WEPN	200	50		20	60	250



WEPNBJM 82 SHORE A

Elastic Poly Nylon

100WEPNBJ	100	38		15	41	250
125WEPNBJ	125	38		15	41	280

Elast
Prene



WEPABJ 80 SHORE A

Elastic Polyurethane
on Aluminium Centre

100WEPABJ15	100	40		12	42	300
125WEPABJ15	125	40		12	44	350
160WEPABJ20	160	50		20	60	600
200WEPABJ20	200	50		20	60	800



WPTABJ

Polyurethane on
Aluminium Centre

80WPTABJ	80	30		12	40	180
100WPTABJ	100	40		15	44	250
125WPTABJ15	125	40		15	44	300
125WPTABJ	125	50		20/25	60	500
150WPTABJ	150	50		20/25	60	550
160WPTABJ	160	50		20/25	60	600
200WPTABJ	200	50		20/25	60	800



WPTPB

Polyurethane Cast Iron
PILOT BORE

125WPTPB	125	50		19.5/31.5	50	600
150WPTPB	150	50		19.5/31.5	52	900
200WPTPB	200	50		19.5/31.5	52	1200
250WPTPB	250	50		24.5/36.5	60	1400
300WPTPB	300	50		24.5/36.5	60	1500
200WPT75PB	200	75		24.5	60	1800
250WPT70PB	250	70		24.5	75	2000
300WPT75PB	300	75		24.5	75	2300

Extra High Resilience Polyurethane. Bore and keyway service available.

WHEELS



WIRPUBJ

Polyurethane on Cast Iron Core

100WIRPUBJ	100	50		17	60	260
125WIRPUBJ	125	50		17	60	350
150WIRPUBJ	150	50		17	60	400
200WIRPUBJ	200	50		17	60	450



WHPT

Polyurethane on Cast Iron Core

200WHPTBJ	200	75		20/25	82	1800
250WHPTBJ	250	75		20/25	82	2500
300WHPTBJ	300	75		20/25	82	2800
400WHPTBJ	400	100		30/35	108	4500



WPTBJ

Polyurethane on Cast Iron Centre

50WPT	50	14		12	17	80
100WPT38BJ	100	38		20/25	45	300
125WPT38BJ	125	38		20/25	43	450
100WPTBJ	100	50		20/25	60	450
125WPTBJ	125	50		20/25	60	550
150WPTBJ	150	50		20/25	60	800
200WPTBJ	200	50		20/25	60	1000
250WPTBJ	250	50		20/25	60	1300



200WPT75BJ	200	75		20/25	82	1400
250WPT75BJ	250	75		20/25	82	1800
300WPT75BJ	300	75		20/25	82	2200
200WPT100BJ	200	100		25/30/35	100	1800
250WPT100BJ	250	100		25/30/35	100	2000
300WPT100BJ	300	100		25/30/35	100	2600



WPTBJRP

Round Profile Polyurethane on Cast Iron Centre

100WPTBJRP	100	50		20/25	50	350
125WPTBJRP	125	50		20/25	56	400
150WPTBJRP	150	50		20/25	56	650
200WPTBJRP	200	50		20/25	56	800

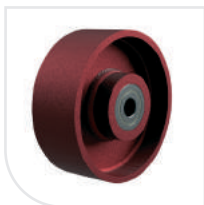

WDIBJ

Ductile Iron

200WDIBJ	200	75		25	82	2500
250WDIBJ	250	75		25	82	2700
300WDIBJ	300	75		25	82	2900

WHEELS



WCI/B/BJ Cast Iron						
50WST	50	14		12	17	135
100WCI38B	100	38		12	46	350
100WCI38BJ	100	35		20	44	350
125WCI38BJ	125	35		20	44	400
100WCIBJ	100	50		20	60	450
125WCIBJ	125	40		20	60	650
150WCIBJ	150	45		20	60	900
200WCIBJ	200	45		20/25	60	1100
250WCIBJ	250	54		20/25	60	1500
WHT/G/BJ/WAN High Temperature Resistant Wheels						
100WHT 220 (PHENOLIC RESIN)	100	38		10	45	150
100WHTG280 (EPOXY RESIN)	100	38		15	40	200
100WRTBJHT - 250°C (RUBBER)	100	35		15	40	300
150WAN19 - 120°C (PHENOLIC RESIN)	150	50		19.1	56	400
200WAN19 - 120°C (PHENOLIC RESIN)	200	50		19.1	56	500
150WAN19 - 220°C (PHENOLIC RESIN)	150	50		19.1	56	400
200WAN19 - 220°C (PHENOLIC RESIN)	200	50		19.1	56	500
150WAN19 - 300°C (PHENOLIC RESIN)	150	50		19.1	56	400
200WAN19 - 300°C (PHENOLIC RESIN)	200	50		19.1	56	500

WHEELS



WHEELS



WNYBJG

Nylon

80WNYBJG	80	30		8/10	40	220
80WNYBJG/45	80	30		8/10	45	220
100WNYBJGHD	100	32		8/10	40	250
100WNYBJG/45	100	32		8/10	45	250
125WNYBJG	125	32		8/10	45	250



WPNBJG

Poly Nylon

100WPNBJG	100	35		8/10	45	200



WHTBJG

High Temperature
Polymer Glass Fibre

80WHT	80	30		12	40/44	280
80WHTBJG*	80	30		8/10	40	280
80WHTBJG/45*	80	30		8/10	45	280
100WHT	100	32		12	40/44	300
100WHTBJG*	100	32		8/10	40	300
100WHTBJG/45*	100	32		8/10	45	300
125WHT	125	40		15	45	400
125WHTBJG*	125	40		8/10	44	400

*280°C FOR SHORT PERIODS ONLY



WPP

Polypropylene

50WPP	50	20		6	22	40
75WPP	75	21		8	30	50
80WPP	80	35		12	40	150
100WPPDL	100	26		12	32	80
100WPP	100	35		12	40	180
125WPP	125	26		12	32	100
80WPPB	80	35		12	40	150
100WPPB	100	35		12	40	180
125WPPB	125	35		12	44	220
50WPP-BLACK	50	20		6	22	40
75WPP-BLACK	75	21		8	30	50
100WPP-BLACK	100	26		12	32	80
125WPP-BLACK	125	26		12	32	100



WAPP

Nylon

100WAPPBJ	100	50		15	60	260
125WAPPBJ	125	50		15	60	350
150WAPPBJ	150	50		15	60	400
200WAPPBJ	200	50		15	60	450

WHEELS



WNY

Nylon

50WNY12	50	14		12	17	80
50WNY - BLACK	50	17		8	21	50
50WNY8	50	20		8	25	50
50WNYI	50	25		6.4	27	60
50WNYHD	50	30		8	40	60
63WNY	63	28		9.5	33	80
75WNYL	75	24		8	26	90
75WNY - BLACK	75	25		12	39	170
75WNY	75	25		12	39	170
75WNYI	75	31		12.7	40	110
80WNY	80	35		12	40	200
100WNY	100	35		12	40	200
125WNY	125	35		12	44	270
150WNY	150	40		20	58	350
150WNYHD	150	45		20	58	800
160WNY	160	45		20	58	350
200WNY	200	50		20	58	500

*Glass fibre nylon wheels available -40° - +130°.



WNYB

Nylon

80WNYB	80	35		12	40	200
100WNYB	100	35		12	40	200
100WNYB/45	100	32		12	45	250
125WNYB	125	35		12	44	270
125WNYBHD	125	45		20	58	750
150WNYB	150	40		20	58	350
160WNYB	160	45		20	58	350
200WNYB	200	50		20	58	500



WNYBJ

Nylon

100WNYBJHD	100	40		15	45	650
125WNYBJ	125	35		15	40	400
125WNYBJHD	125	45		20	58	750
150WNYBJ	150	45		20	58	700
150WNYBJHD	150	45		20	58	1000
200WNYBJ	200	50		20	58	800
200WNYBJHD	200	50		20	58	1000
250WNYBJ	250	60		25	60	1400



WCNYBJ

Nylon

200WCNYBJ	200	80		45	80	4500
250WCNYBJ	250	80		50	80	5000
300WCNYBJ	300	80		55	80	7000

WHEELS



WLBS						
Rubber on Steel						
350WLBSB	350	80		20/25/25.4	66	400
400WLBSB	400	100		20/25/25.4	66	700



WSHM						
Rubber on Plastic						
260WSHM25.4	260	95		25.4	59	125

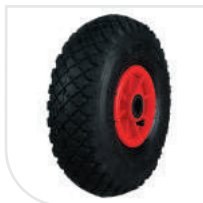

WATP						
Pneumatic on Plastic						
200WATPB	200	50		20	60	75
260WATPB	260	85		20	75	125



WATM						
Pneumatic on Steel						
200WATMR	200	50		20	60	75
370WATMRBM	370	85		20/25/25.4	66	180
400WATMRBM	400	100		20/25/25.4	66	300
400WATMB	400	100		25	75	350



WATMBJ						
Pneumatic on Steel						
200WATMBJ	200	56		17	70	136
260WATMBJ	260	83		16	100	158
300WATMBJ	300	83		16	100	204
300WATMBJM25	300	105		25	75	120



WATMBJ OFFSET						
Pneumatic on Steel						
260WATMBJM16/56OSH	260	85		16	56	150

WHEELS



WHEELS

	WATP Flat Free PU Environmental Polyurethane						
	260WATPB/MICROCEL	260	85		20	75	125
	WATMRBM Flat Free PU Environmental Polyurethane						
	200WATMRBM/MICROCEL	200	50		20	58	125
	370WATMRBM/MICROCEL	370	85		20/25/25.4	60	180
	WATM Flat Free PU Environmental Polyurethane						
	400WATMRBM/MICROCEL	400	100		20/25/25.4	66	300
	WATPL Flat Free PU Environmental Polyurethane						
	400WATPLM254/75/MICROCEL	400	95		25.4	75	120
	400WATPLRBM254/75/MICROCEL	400	95		25.4	75	120
	WATML Flat Free PU Environmental Polyurethane						
	400WATMLM254/75/MICROCEL	400	95		25.4	75	120
	400WATMLRBM254/75/MICROCEL	400	95		25.4	75	120
	WATMBJ OFFSET Flat Free PU Environmental Polyurethane						
	260WATMBJM16/56OSH/MICROCEL	260	85		16	56	150

SCENE SHIFTERS

SERIES: ICSKATE

BRACKET: **FABRICATED**
BEARING: **PLAIN/BALL BEARING**



WHEELS

ICSKATE

SWIVEL

NYLON

ICS/50NB2LLNY	50	14		135x110	105x80	10	95	300
ICS/100DRHBH12NYBJ	100	35		135x110	105x80	13	163	460
ICS/125DRHBH12NYBJ	125	35		135x110	105x80	13	183	460

STEEL

ICS/50NB2LLST	50	14		135x110	105x80	10	95	300
---------------	----	----	--	---------	--------	----	----	-----

BLUE ELASTICATED

ICS/100DRHBH12BNB	100	36		135x110	105x80	13	163	460
ICS/125DRHBH12BNB	125	36		135x110	105x80	13	183	460

CAST IRON

ICS/100DRHBH12CIBJ	100	36		135x110	105x80	13	163	460
ICS/125DRHBH12CIBJ	125	38		135x110	105x80	13	183	460

POLY ALUMINIUM

ICS/100DRHBH12PTABJ	100	40		135x110	105x80	13	163	460
ICS/125DRHBH12PTABJ	125	40		135x110	105x80	13	183	460

POLY CAST IRON

ICS/35NBLL2PTBJ	35	28		85x85	55x55	10	85	300
ICS/50NB2LLPT	50	14		135x110	105x80	10	95	300
ICS/100DRHBH12PTBJ	100	38		135x110	105x80	13	163	460
ICS/125DRHBH12PTBJ	125	38		135x110	105x80	13	183	460

RUBBER CAST IRON

ICS/100DRHBH12RTBJ	100	36		135x110	105x80	13	163	460
ICS/125DRHBH12RTBJ	125	38		135x110	105x80	13	183	460



PLATE OPTIONS

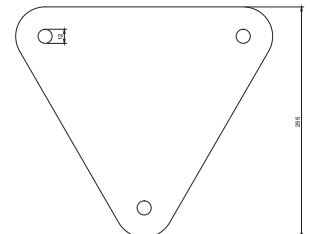
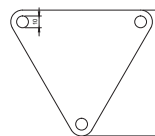
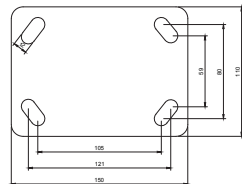
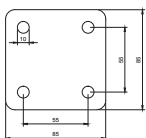



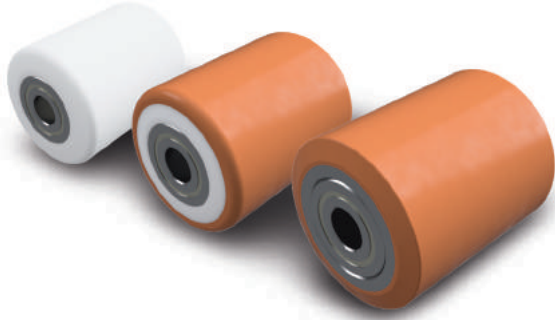











PALLET ROLLERS

































PALLET ROLLERS NYLON OR POLYURETHANE

Pallet Rollers are specifically designed as replacement pallet rollers on pallet trucks and fork lift trucks. With an extra wide tread and ball journal bearings these durable and robust hardworking pallet rollers can take loads of up to 950k.

With a variety of pallet roller wheel diameters to suit your requirements in either polyurethane or nylon.

	NYLON						
							
82x60WNYBJM	82	60		17/20/25	60	600	
82x70WNYBJM	82	70		17/20/25	70	700	
82x100WNYBJM	82	100		17/20/25	100	1000	
85x60WNYBJ	85	60		17/20/25	60	600	
85x70WNYBJ	85	70		17/20/25	70	700	
85x90WNYBJ	85	90		17/20/25	90	900	
85x100WNYBJ	85	100		17/20/25	100	1000	

	POLYURETHANE						
	Polyurethane on Nylon						
							
82x70WPNBJ	82	70		17/20/25	70	500	
82x100WPNBJ	82	100		17/20/25	100	850	
85x90WPNBJ	85	90		17/20/25	90	750	

	POLYURETHANE						
	Polyurethane on Cast Iron						
							
70x70WPTBJM	70	70		15	70	500	
75x75WPTBJM	75	75		17/20/25	75	570	
80x60WPTBJM	80	60		17/20/25	60	550	
82x60WPTBJM	82	60		17/20/25	60	600	
82x70WPTBJM	82	70		17/20/25	70	700	
82x75WPTBJM	82	75		17/20/25	75	750	
82x90WPTBJM	82	90		17/20/25	90	900	
82x100WPTBJM	82	100		17/20/25	100	1000	
85x60WPTBJM	85	60		17/20/25	60	700	
85x70WPTBJM	85	70		17/20/25	70	700	
85x75WPTBJM	85	75		17/20/25	75	750	
85x80WPTBJM	85	80		17/20/25	80	800	
85x90WPTBJM	85	90		17/20/25	90	900	
85x100WPTBJM	85	100		17/20/25	100	1000	

EXPANDERS & ACCESSORIES

EXPANDERS



ES	INSIDE-TUBE MEASUREMENT	TUBE
Square Expander		
ES21.5	19-21.5	SQUARE
ES24	21.5-24	SQUARE
ES27	24-27	SQUARE
ES30	27-30	SQUARE
ES35	32-35	SQUARE
ES40	36-40	SQUARE



ER	INSIDE-TUBE MEASUREMENT	TUBE
Round Expander		
ER21.5	19-21.5	ROUND
ER24	21.5-24	ROUND
ER27	24-27	ROUND
ER30	27-30	ROUND
ER35	32-35	ROUND
ER40	36-40	ROUND

ACCESSORIES



SPRING LOADED GATE CASTOR

SPECIAL PURPOSE CASTOR SPECIFICALLY DESIGNED TO HELP SUPPORT THE ENDS OF WIDE SWING GATES OR DOORS, HELPING REDUCE STRESSES AND STRAINS ON SUPPORTS AND HINGES, AND AID SMOOTHER OPERATION. THEY WILL PROVIDE UP TO 70KG OF SUPPORT AND CAN ACCOMMODATE A MAXIMUM OF 75MM/3" OF UPWARDS COMPRESSION/GROUND HEIGHT VARIATION.



KEY DIMENSIONS

Side Elevation

Fixing Plate

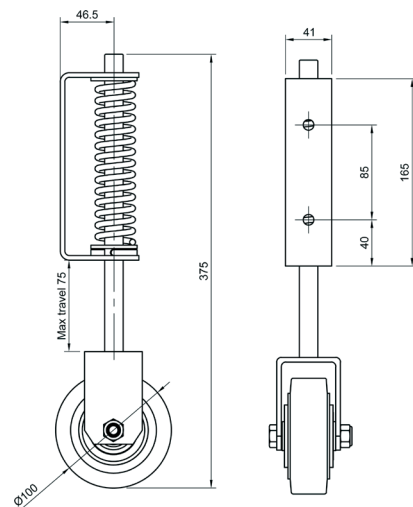

ADJUSTABLE FEET



ADJUSTABLE FEET

MILD STEEL BRIGHT ZINC PLATE STEMS WITH PLASTIC BASES

STEMS: MILD STEEL BZP BASES: POLYPROPYLENE



25MM TO 55MM
80MM TO 105MM
STEMS
BASES
WEIGHT

CONICAL ONLY
CONICAL OR BOLT DOWN
MILD STEEL BRIGHT ZINC PLATE STEMS
POLYPROPYLENE
50KG - 450KG

STAINLESS STEM & PLASTIC BASES

STEMS: STAINLESS STEEL BASES: POLYPROPYLENE BLACK OR WHITE



25MM TO 55MM
80MM TO 105MM
STEMS
BASES
WEIGHT

CONICAL ONLY
CONICAL OR BOLT DOWN
STAINLESS STEEL
POLYPROPYLENE BLACK OR WHITE
50KG - 450KG

SOLID STAINLESS STEEL STEMS & BASES

STEMS: STAINLESS STEEL BASES: STAINLESS STEEL



38MM TO 76MM
76MM TO 102MM
STEMS
BASES
WEIGHT

CONICAL ONLY
CONICAL OR BOLT DOWN
STAINLESS STEEL
STAINLESS STEEL
300KG - 2000KG

STEPS / STEP TRAY TROLLEYS

STEP LADDERS

All classic models are fully welded throughout and available with ribbed rubber or anti-slip treads.

Close fitting continuous single rail guard around top platform, extending down each side of stairway as a short handrail.	Spiggot OD 18.5mm*
Fitted with dome covered spring loaded, 50mm dia swivel castors which retract when weight is applied to the steps, giving them firm contact with the floor.	Spiggot Length 85mm
Grey non marking tyres.	Fixing Hole dia: 5mm
Dome covers have a double rolled bottom edge together with a protective cover strip, giving a neat appearance and reasonable protection to carpets and other floor surfaces.	Fixing hole centre from base of tube 10mm
	The I/D of the tube on the step itself that we have is 24.1mm* so there is a fair amount of clearance / tolerance.



TREAD (INC PLATFORM)	2	3	4	5
AVERAGE WORKING HEIGHT	2.00M	2.26M	2.52M	2.77M
PLATFORM HEIGHT MM	508	762	1016	1270
PLATFORM WIDTH MM	380	380	380	380
PLATFORM DEPTH MM	280	280	280	280
O/ALL H (INC RAILS)MM	1185	1425	1683	1940
O/ALL WIDTH MM	580	580	580	580
O/ALL DEPTH MM	540	795	955	1120
WEIGHT KGS	12	14	17	20
RIBBED RUBBER TREADS REF	S005	S009	S011	S013
ANTI SLIP TREADS REF	S006	S010	S012	S014

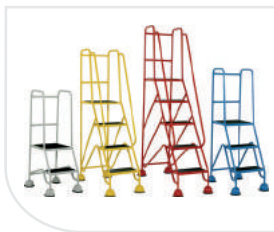

TREAD (INC PLATFORM)	2	2	2	3	4	5
HANDRAILS	NONE	SINGLE	FULL	FULL	FULL	FULL
PLATFORM HEIGHT MM	508	508	508	762	1016	1270
PLATFORM WIDTH MM	406	406	406	406	406	406
PLATFORM DEPTH MM	380	380	380	380	380	380
O/ALL H (INC RAILS)MM	570	1175	1175	1430	1680	1935
O/ALL WIDTH MM	556	556	556	556	556	556
O/ALL DEPTH MM	650	650	650	790	1005	1225
WEIGHT KGS	7	9	11	14	17	20
RIBBED RUBBER TREADS REF	S218	S220	S221	S222	S223	S224
ANTI SLIP TREADS REF	S219	S225	S226	S227	S228	S229

STEP TRAY TROLLEYS



3 Step, 3 Tray Tiers

Spring loaded step unit, with ribbed rubber treads, locates firmly on floor when foot placed on first step, immobilising trolley.

Top tread height 686mm

Fully welded construction, from RSA angle and ERW tube. Rubber feet fitted to step unit. Blue Epoxy finish.



5 Step, 3 Tray Tiers

Fully welded from RSA angle and ERW tubes.

Fitted with 2 retractable castors in front and 2 fixed castors to rear, each with 125mm rubber tyred wheels and roller bearings.

Front castors retract with hand operated lever to immobilise trolley. Fixed steps, handrail fitted to each side and across the top.

HOOF CASTOR

Hoof Cup Feet steps are mounted on retractable spring castors to enable the steps to be easily moved into position. When under the operator weight steps lower to grip the floor.

Spiggot OD 18.5mm*

Spiggot Length 85mm

Fixing Hole dia: 5mm

Fixing hole centre from base of tube 10mm

The I/D of the tube on the step itself that we have is 24.1mm* so there is a fair amount of clearance / tolerance!

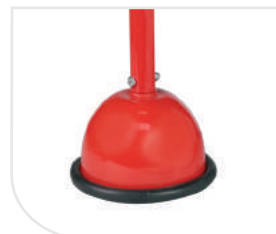

TRAY TROLLEYS

CLASSIC TRAY TROLLEYS

Choice of elegant and smart removable and reversible white or blue trays in blue frame, or fixed ply shelves. Tough durable epoxy finish throughout.

2 or 3 removable steel trays or fixed ply shelves.	125mm dia.
Removable and reversible steel trays for flush or recessed fitting.	Stem fitting castors.
Welded tube and angle construction.	Grey non marking tyres with thread guards.
Overall height 1065mm.	Max load: 200kg



NO. OF TRAYS	2-TRAYS		3-TRAYS	
TRAY SIZE L X W MM	760 x 457	2.00M	2.00M	2.00M
TRAY HEIGHTS MM	245 : 945	508	508	508
WEIGHT KGS	25	380	380	380
ICTTW SERIES REF WHITE EPOXY TRAYS	ICTT62	ICTT66	ICTT63	ICTT67
ICTTB SERIES REF BLUE EPOXY TRAYS	ICTT72	ICTT76	ICTT73	ICTT77
TT60 SERIES REF FIXED PLY TRAYS	ICTT60 20	ICTT64 31	ICTT61 27	ICTT65 41

HEAVY DUTY TRAY TROLLEYS

Special heavyweight tray trolleys custom built to your specification if required. Strong construction from square and round section steel tubes and steel shelves with lip.

3 removable steel trays or fixed ply shelves.	200mm dia.
Solid rubber tyre	Red centred wheels fitted
Welded tube and angle construction.	Roller bearing.
Finish Blue epoxy.	Max load: 350kg



NO. OF TRAYS	3-TRAYS	
HEIGHT MODEL	900MM	1200MM
O/A LENGTH X WIDTH X HEIGHT	1090 x 500 x 900	1090 x 500 x 1200
EXTERNAL TRAY SIZE L X W	900 x 500	900 x 500
BOTTOM SHELF HEIGHT	280	280
MIDDLE SHELF HEIGHT	590	740
TOP SHELF HEIGHT	900	1200
WEIGHT KGS	56	58
REF	ICTT34	ICTT35

TABLE TRUCKS

TABLE TRUCKS

Ideal truck series for tough work in Stores, Warehouses, Factories and Workshops.

Welded steel construction throughout.	Wheels: 2 fixed 2 swivel castors
Overall length = Deck length + 135mm	200mm dia. Rubber tyred wheels.
Overall width = Deck width + 20mm	Max load: 500kg
Finish: Blue epoxy.	

RECESSED DECK OPTION

Recessed top and bottom decks optional at no extra cost.
Add suffix RD to chosen Ref.



DECK SIZE	1000 X 600MM		1000 X 700MM		1200 X 800MM	
TYPE	TOP DECK ONLY	TOP AND BOTTOM DECK	TOP DECK ONLY	TOP AND BOTTOM DECK	TOP DECK ONLY	TOP AND BOTTOM DECK
TIMBER DECK REF WEIGHT KGS	ICTT205T 42	ICTT200T 52	ICTT230T 46	ICTT210T 56	ICTT240T 53	ICTT220T 66
STEEL DECK REF WEIGHT KGS	ICTT205S 40	ICTT200S 48	ICTT230S 44	ICTT210S 52	ICTT240S 50	ICTT220S 64

NARROW AISLE SHELF TRUCKS

SHELF TRUCKS

Ideal for Warehouses, Stores, Supermarkets, Factories, Offices. 1,2,3 and 4 deck models.

Overall Length x Width: 1070 x 600mm	High quality red epoxy coated finish tubular chassis frame.
Overall Height: 1,2 & 3 deck models: 1160mm	2 fixed 2 swivel castors with 160mm dia. Rubber tyred wheels with bright steel centres. Brakes optional.
Overall Height 4 deck model: 1500mm	Bright zinc plated mesh infill panels as required.
Deck Length x Width 1000 x 600mm	Fixed timber shelves with bright steel protector strips on both long sides.
Smart and attractive, narrow overall width - only 600mm	



ICTT100 2 DECKS		DECKS AT: 290 : 880MM	
	COMBINATIONS	WEIGHTS KGS	REF
MODEL A	2 fixed open ends	38	ICTT100



ICTT100 3 DECKS		DECKS AT: 290 : 650 : 1010MM	
	COMBINATIONS	WEIGHTS KGS	REF
MODEL B	2 fixed open ends	46	ICTT113



ICTT100 4 DECKS		DECKS AT: 290 : 650 : 1010 : 1370MM	
	COMBINATIONS	WEIGHTS KGS	REF
MODEL C	2 fixed open ends	57	ICTT116

BOOKLET TROLLEYS

Popular design for libraries, offices, classrooms, laboratories etc.

Popular design for libraries, offices, classrooms, laboratories etc.
Single with flat shelves and double sided with angled shelves.
Strong all steel construction finished in cream epoxy.
Overall L x W: 840 x 470mm.

Fitted with 4 swivel castors 100mm, grey non-marking tyres and thread guards.
Available in Different colours.
Max Load: 150kg



2 TIER	SINGLE SIDED	DOUBLE SIDED	3 TIER	SINGLE SIDED	DOUBLE SIDED
O/A HEIGHT	940	955	O/A HEIGHT	1265	1325
SHELF HEIGHTS	185 / 580	185 / 655	SHELF HEIGHTS	185 / 540 / 895	185 / 600 / 1020
O/A L X W	840 x 390	840 x 470	O/A L X W	840 x 390	840 x 470
WEIGHT KGS	27	35	WEIGHT KGS	38	46
RED REF	ICTT24/R	ICTT21/R	RED REF	ICTT25/R	ICTT22/R
GREEN REF	ICTT24/G	ICTT21/G	GREEN REF	ICTT25/G	ICTT22/G
YELLOW REF	ICTT24/Y	ICTT21/Y	YELLOW REF	ICTT25/Y	ICTT22/Y
BLUE REF	ICTT24/B	ICTT21/B	BLUE REF	ICTT25/B	ICTT22/B

Double sided with angled shelves.
Tubular steel frame with sheet steel shelves.
Overall L x W x H: 880 x 550 x 1115mm
Available in different colours.

Fitted with 4 swivel castors 125mm grey non-marking tyres and thread guards.
Weight: 37kg
Max load: 250kg





INTERNATIONAL CASTOR CO. LTD

Palmers Road | East Moons Moat
Redditch | B98 0RF

telephone **01527 501 145**

fax **01527 520 156**

e-mail info@internationalcastorcoltd.co.uk

www.internationalcastorcoltd.co.uk